

# EG4<sup>®</sup> 6000XP OFF-GRID INVERTER

## USER MANUAL



## TABLE OF CONTENTS

1.	TECHNICAL SPECIFICATIONS .....	1
2.	ABBREVIATIONS .....	1
3.	INVERTER SAFETY .....	2
3.1	SAFETY INSTRUCTIONS.....	2
3.2	IMPORTANT SAFETY NOTIFICATIONS .....	2
4.	BRIEF INTRODUCTION.....	4
4.1	INVERTER FEATURES.....	4
4.2	INVERTER INTERFACE .....	5
5.	INSTALLATION .....	6
5.1	PACKING LIST .....	6
5.2	LOCATION SELECTION AND INSTALLATION.....	6
5.3	STORAGE INFORMATION .....	7
5.3.1	INSTALLING THE INVERTER.....	8
5.4	CONNECTION OVERVIEW.....	9
5.4.1	SYSTEM CONNECTIONS .....	9
5.5	PV CONNECTION .....	9
5.5.1	CONNECTING PV TO THE INVERTER.....	9
5.5.2	STRING SIZING.....	10
5.5.3	PV WIRING INSTRUCTIONS .....	11
5.6	BATTERY CONNECTION.....	13
5.6.1	BATTERY CABLE CONNECTION .....	13
5.6.2	LITHIUM BATTERY COMMUNICATIONS.....	14
5.7	AC WIRING INFORMATION.....	14
5.7.1	STEPS FOR AC CONNECTION .....	15
5.8	WORKING WITH A GENERATOR .....	15
5.8.1	GENERATOR SYSTEM CONNECTION.....	15
5.8.2	INTEGRATED TWO-WIRE START/STOP.....	16
5.8.3	GENERATOR AC CONNECTIONS.....	17
5.9	GENERATOR START AND STOP SETTINGS.....	17
5.10	OFF-GRID.....	18
5.10.1	OFF-GRID WIRING .....	18
5.11	AC COUPLING INSTALLATION CONNECTION.....	18
5.12	PARALLELING INFORMATION .....	19
5.12.1	PARALLEL COMMUNICATION CONNECTIONS.....	19
5.12.2	PARALLEL CONFIGURATION .....	19
6.	END USER SETTINGS.....	21
6.1	APPLICATION SETTING.....	21
6.2	CHARGE SETTING.....	21
6.2.1	GENERATOR CHARGE .....	22
6.3	DISCHARGE SETTING.....	23
6.4	AC COUPLE.....	23
6.5	SMART LOAD.....	23
6.6	RESET .....	24

7.	INSTALLER SETTINGS .....	24
7.1	COMMON SETTING .....	24
7.2	APPLICATION SETTING .....	25
7.3	CHARGE SETTING .....	26
7.4	DISCHARGE SETTING.....	27
7.5	AC COUPLE .....	28
7.6	SMART LOAD.....	28
7.7	OTHER SETTING .....	29
7.8	RESET .....	29
8.	MONITOR SYSTEM SETUP .....	30
8.1	WI-FI/4G/LAN DONGLE CONNECTION.....	30
8.2	THIRD-PARTY RS485 COMMUNICATION.....	30
8.3	ONLINE MONITORING SYSTEM USER INTERFACE .....	31
8.3.1	DASHBOARD (MONITOR TAB).....	31
8.3.2	DASHBOARD (DATA TAB).....	34
8.3.3	DASHBOARD (CONFIGURATION TAB).....	37
8.3.4	DASHBOARD (OVERVIEW TAB).....	38
8.3.5	DASHBOARD (MAINTENANCE TAB).....	39
9.	FIRMWARE UPDATES.....	39
9.1	FIRMWARE UPDATE VIA EG4 ELECTRONICS APP.....	39
9.2	FIRMWARE UPDATE VIA MONITOR CENTER (WEBSITE).....	40
10.	SMARTPHONE APP SETUP .....	42
11.	WORKING MODES .....	43
11.1	RAPID SHUTDOWN (RSD).....	44
11.1.1	EXTERNAL RSD WIRING INSTRUCTIONS .....	45
11.2	LCD DISPLAY AND SETTINGS .....	46
11.2.1	LCD DISPLAY .....	46
12.	LCD SETTINGS .....	48
13.	INVERTER START-UP AND SHUT-DOWN PROCEDURE.....	62
13.1	START-UP .....	62
13.2	SHUT-DOWN .....	62
14.	STATUS, WARNING, & ERROR CODES.....	63
14.1	STATUS CODES .....	63
14.2	WARNING CODES .....	64
14.3	FAULT CODES.....	66
15.	INVERTER MAINTENANCE .....	69
16.	WARRANTY INFORMATION.....	69

## 1. TECHNICAL SPECIFICATIONS

<b>AC INPUT DATA</b>			
NOMINAL AC VOLTAGE	120/240VAC (L1/L2/N required)		
FREQUENCY	50/60Hz		
MAX. CONTINUOUS AC CURRENT	37.5A @ 240VAC		
MAX. AC INPUT POWER	9000W		
AC BYPASS (GRID   GENERATOR)	50A   50A		
<b>AC OUTPUT DATA</b>			
OUTPUT VOLTAGE	120/240VAC		
OUTPUT FREQUENCY	50/60Hz		
MAX. CONTINUOUS OUTPUT CURRENT @ 240V	25A		
MAX CONT. LINE WATTAGE	3000W		
NOMINAL POWER OUTPUT	6000W		
SURGE CAPACITY	12,000W for ≈3.5 seconds   11,000W for ≈5 seconds		
POWER FACTOR VALUE	0.6 – 1		
OPERATING FREQUENCY	50/60Hz		
THD (V)	<3%		
SWITCHING TIME	<15ms @ Single / <30ms @ Parallel		
<b>PV INPUT DATA</b>			
NUMBER OF MPPTS	2		
INPUTS PER MPPT	1		
MAX. USABLE INPUT CURRENT	17/17A		
MAX. SHORT CIRCUIT INPUT CURRENT	25/25A		
DC INPUT VOLTAGE RANGE	100-480VDC		
UNIT STARTUP VOLTAGE	100VDC ± 10VDC		
MPP OPERATING VOLTAGE RANGE	120-385VDC		
NOMINAL MPPT VOLTAGE	320VDC		
MAXIMUM UTILIZED SOLAR POWER	8000W (4000W per MPPT)		
RECOMMENDED MAXIMUM SOLAR INPUT	10000W (5000W per MPPT)		
<b>EFFICIENCY</b>			
MPPT EFFICIENCY	99%		
BATTERY CHARGING EFFICIENCY	93%		
BATTERY DISCHARGING EFFICIENCY	93%		
IDLE CONSUMPTION (STANDBY MODE*)	W/ PV <30W	w/ Battery ≈50W	w/ AC <50W
<b>BATTERY DATA</b>			
TYPE	Lead-acid/Lithium		
MAX. DISCHARGE CURRENT	140A		
MAX. CHARGE CURRENT	125A**		
NOMINAL VOLTAGE	48VDC		
BATTERY VOLTAGE RANGE	46.4-60VDC (Lithium); 38.4-60VDC (Lead-Acid)		
REC. BATTERY CAPACITY PER INVERTER	>200Ah		
HIGH DC CUT-OFF VOLTAGE	59VDC (Lithium)   60VDC (Lead-acid)		

HIGH DC RECOVERY VOLTAGE		57.4VDC(Lithium)   58VDC(Lead-Acid)
	LOAD<20%	44.0VDC (Configurable)
LOW DC WARNING VOLTAGE (LEAD-ACID)	20%≤LOAD<50%	Warning Voltage @Load <20% - 1.2V
	LOAD≥50%	Warning Voltage @Load <20% - 3.6V
LOW DC WARNING VOLTAGE RETURN (LEAD-ACID)		Low DC Warning Voltage @Different Load +2V
	LOAD<20%	42.0VDC (Configurable)
LOW DC CUT-OFF VOLTAGE (LEAD-ACID)	20%≤LOAD<50%	Cut-Off Voltage @Load <20% - 1.2V
	LOAD≥50%	Cut-Off Voltage @load <20% - 3.6V
LOW DC CUT-OFF RETURN VOLTAGE (LEAD-ACID)	CUT-OFF VOLTAGE @LOAD <20% ≥45V	Low DC Cut-Off Voltage @load <20% +3V
	CUT-OFF VOLTAGE @LOAD <20% <45V	48V
LOW DC WARNING SOC		20% SOC (Configurable)
LOW DC WARNING RETURN SOC		Low DC Warning SOC +10%
LOW DC CUT-OFF SOC		15% SOC (Grid ON) (Configurable)
		15% SOC (Grid OFF) (Configurable)
LOW DC CUT-OFF RETURN SOC		Low DC Cut-Off SOC +10%
CHARGE CUT-OFF VOLTAGE		58.4VDC
<b>GENERAL DATA</b>		
MAX. UNITS IN PARALLEL		16
INTEGRATED DISCONNECT		Yes
DC SWITCH RATING FOR EACH MPPT		Yes
DIMENSIONS		18×25.5×5.25 in (457×648×132mm)
WEIGHT		52.9 lbs. (24kg)
COOLING CONCEPT		Fan
TOPOLOGY		TL (Transformerless)
RELATIVE HUMIDITY		5-95%
ALTITUDE		<6561ft (2000m)
OPERATING TEMPERATURE RANGE		32 – 113°F (0 – 45°C)
STORAGE TEMPERATURE RANGE		5 – 140°F (-15 – 60°C)
NOISE EMISSION (TYPICAL)		<58 dB
DISPLAY		LCD + LED
COMMUNICATION INTERFACE		RS485/Wi-Fi/CAN
STANDARD WARRANTY		5-year standard warranty***
PV REVERSE POLARITY PROTECTION, POLE SENSITIVE LEAKAGE CURRENT MONITORING UNIT, SURGE PROTECTION DEVICE, OUTPUT OVER-VOLTAGE PROTECTION, OUTPUT OVER-VOLTAGE PROTECTION VARISTOR		Yes
<b>STANDARDS AND CERTIFICATIONS</b>		
UL1741		
FCC PART 15, CLASS B		
<b>INGRESS PROTECTION RATING</b>		
IP20		

\*Idle consumption value tested with constant 300VDC PV source  
 \*\*115A @ 48VDC (AC), 125A @48VDC (PV)

\*\*\*For information regarding warranty registration on EG4® Electronics products, please navigate to <https://eg4electronics.com/warranty/> and select the corresponding product to begin the registration process.

SCAN FOR LATEST SPEC SHEET



## 2. ABBREVIATIONS

AWG – American Wire Gauge

A – Amps

Ah – Amp hour(s)

AC – Alternating Current

AFCI – Arc-Fault Circuit Interrupter

AHJ – Authority Having Jurisdiction

kAIC – kilo-Amp Interrupting Capability

ANSI – American National Standards Institute

BAT – Battery

BMS – Battery Management System

COM – Communication

CT – Current Transformer

DC – Direct Current

DIP – Dual In-line Package

DOD – Depth of Discharge

EG – Equipment Ground

EGS – Equipment Grounding System

EPS – Emergency Power System

ESS – Energy Storage System

E-Stop – Emergency Stop

E-Stop NO – Emergency Stop Normally Open

FCC – Federal Communication Commission

GE – Grounding Electrode

GEC – Grounding Electrode Conductor

GEN – Generator

GES – Grounding Electrode System

GFCI – Ground-Fault Circuit Interrupter

GFDI – Ground-Fault Detector/Interrupter

IEEE – Institute of Electrical and Electronic Engineers

Imp – Maximum Power Point Current

Isc – Short-circuit Current

In-lbs. – Inch Pounds

IP – Ingress Protection

kW – Kilowatt

kWh – Kilowatt-hour

L1 – Line 1

L2 – Line 2

LCD – Liquid Crystal Display

LFP – Lithium Iron Phosphate or LiFePO<sub>4</sub>

MID – Micro-Grid Interconnection Device

mm – Millimeter(s)

MPPT – Maximum Power Point Tracker

mV – Millivolt(s)

N – Neutral

NEC – National Electric Code

NEMA – National Electrical Manufacturers Association

NFPA – National Fire Prevention Association

Nm – Newton Meters

PC – Personal Computer

PCB – Printed Circuit Board

PE – Protective Earth (G or Ground)

PPE – Personal Protective Equipment

PV – Photovoltaic

RSD – Rapid Shut Down

SOC – State of Charge

STC – Standard Testing Conditions

UL – Underwriters Laboratories

UPS – Uninterrupted Power Supply

V – Volt(s)

Voc – Open-circuit Voltage

Vmp – Voltage Maximum Power

## 3. INVERTER SAFETY

### 3.1 SAFETY INSTRUCTIONS

International safety regulations have been strictly observed in the design and testing of the inverter. Before beginning any work, carefully read all safety instructions, and always observe them when working on or with the inverter. The installation must follow all applicable national or local standards and regulations.

Incorrect installation may cause:

- Injury or death to the installer, operator or third party
- Damage to the inverter or other attached equipment

### 3.2 IMPORTANT SAFETY NOTIFICATIONS



**DANGER:**

#### ***Hazardous Voltage Circuits!***

There are various safety concerns that must be carefully observed before, during, and after the installation, as well as during future operation and maintenance. The following are important safety notifications for the installer and any end users of this product under normal operating conditions.

1. **Beware of high PV voltage.** Install an external DC disconnect switch or breaker and ensure it is in the “off” or “open” position before installing or working on the inverter. Use a voltmeter to confirm there is no DC voltage present to avoid electric shock.
2. **Beware of high grid voltage.** Ensure the AC switch and/or AC breaker are in the “off” or “open” position before installing or working on the inverter. Use a voltmeter to confirm there is no voltage present to avoid electric shock.
3. **Beware of high battery current.** Ensure that the battery module breakers and/or on/off switches are in the “open” or “off” position before installing or working on the inverter. Use a voltmeter to confirm there is no DC voltage present to avoid electric shock.
4. **Do not open the inverter while it is operating to avoid electric shock and damage from live voltage and current within the system.**
5. Do not make any connections or disconnections (PV, battery, grid, communication, etc.) while the inverter is operating.
6. An installer should make sure to be well protected by reasonable and professional insulative equipment [e.g., personal protective equipment (PPE)].
7. Before installing, operating, or maintaining the system, it is important to inspect all existing wiring to ensure that it meets the appropriate specifications and conditions for use.
8. Ensure that the PV, battery, and grid connections to the inverter are secure and proper to prevent damage or injuries caused by improper installation.
9. Some components of the system can be very heavy. Be sure to utilize team-lift among other safe lifting techniques throughout the installation.



## **WARNING: TO REDUCE THE RISK OF INJURY, READ ALL INSTRUCTIONS!**

All work on this product (system design, installation, operation, setting, configuration, and maintenance) must be carried out by qualified personnel. To reduce the risk of electric shock, do not perform any servicing other than those specified in the operating instructions unless qualified to do so.

1. Read all instructions before installing. For electrical work, follow all local and national wiring standards, regulations, and these installation instructions.
2. Make sure the inverter is properly grounded. All wiring should be in accordance with the National Electrical Code (NEC), ANSI/NFPA 70.
3. The inverter and system can inter-connect with the utility grid only if the utility provider permits. Consult with the local AHJ (Authority Having Jurisdiction) before installing this product for any additional regulations and requirements for the immediate area.
4. All warning labels and nameplates on the inverter should be clearly visible and must not be removed or covered.
5. The installer should consider the safety of future users when choosing the inverter's correct position and location as specified in this manual.
6. Keep children from touching or misusing the inverter and relevant systems.
7. **Beware!** The inverter and some parts of the system can be hot when in use. Do not touch the inverter's surface or most of the parts when they are operating. During operation, only the LCD and buttons should be touched.



## **WARNING!**

Cancer and Reproductive Harm – See [www.P65Warnings.ca.gov](http://www.P65Warnings.ca.gov) for more details.

## **DISCLAIMER**

EG4 reserves the right to make changes to the material herein at any time without notice.

Please refer to [www.eg4electronics.com](http://www.eg4electronics.com) for the most updated version of our manuals/spec sheets.



## 4. BRIEF INTRODUCTION

### 4.1 INVERTER FEATURES

- Applicable for purely off-grid inverter/backup power situations.
- Integrated with 2 MPPT solar charge controllers with maximum PV input of 480V with an optimal range of 120VDC-385VDC.
- Additional safety features such as PV Arc Fault Protection and PV Ground Fault Protection.
- Rated for 6kW output, with a power factor of 1.
- Able to run without battery in off-grid mode.
- Able to utilize generators with dedicated generator terminals.
- Supports paralleling for up to 16 inverters.
- Supports CAN/RS485 for lithium battery communications.
- Features remote monitoring and firmware updates via mobile phone app or monitoring system website.

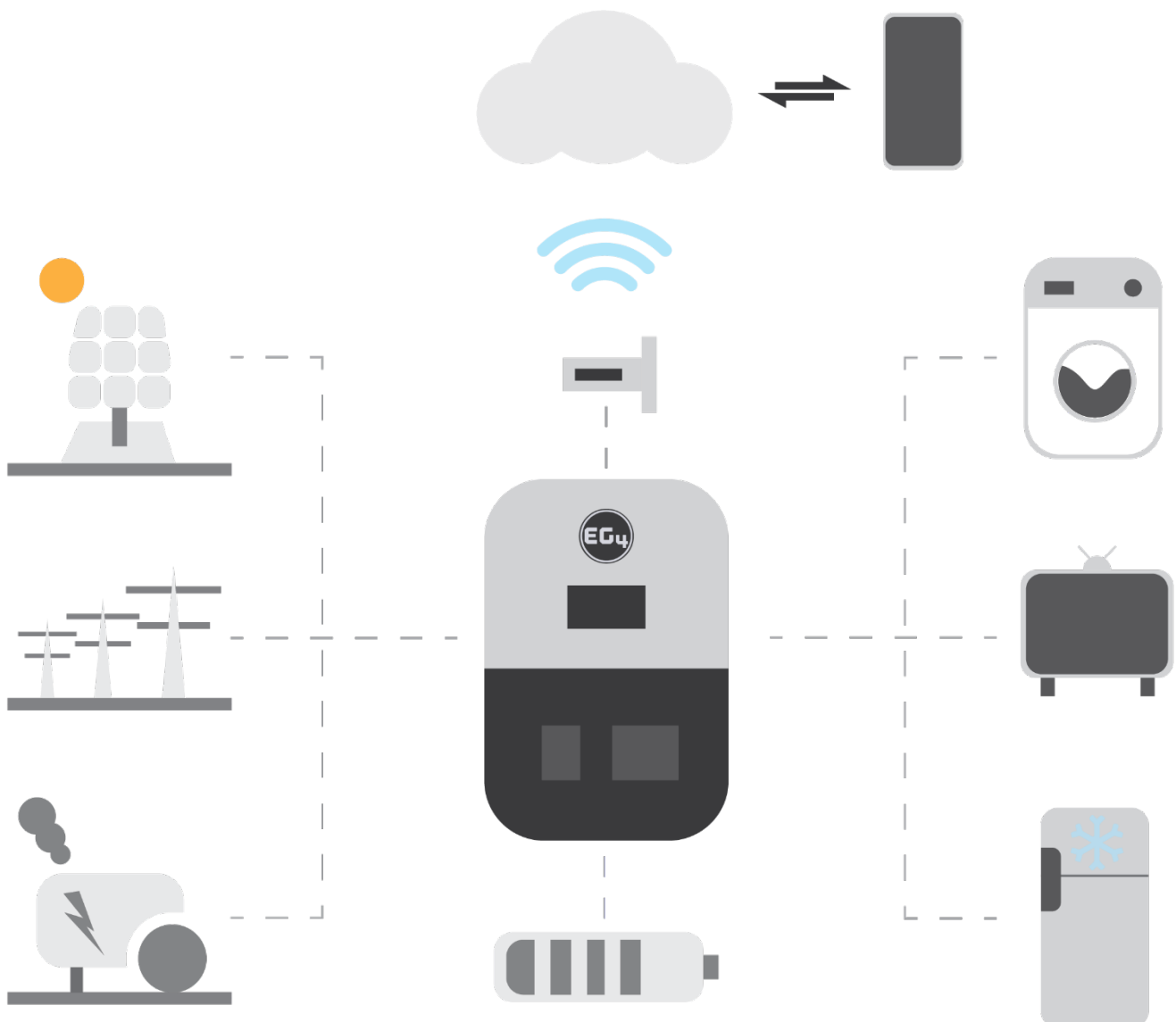



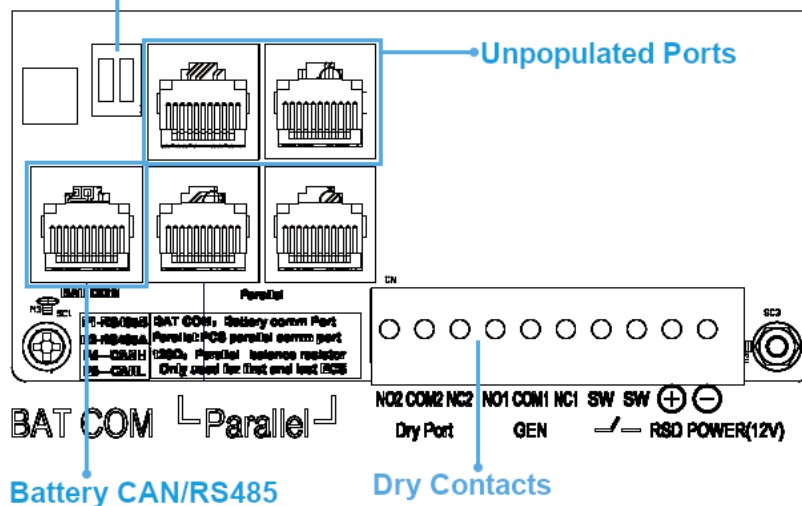
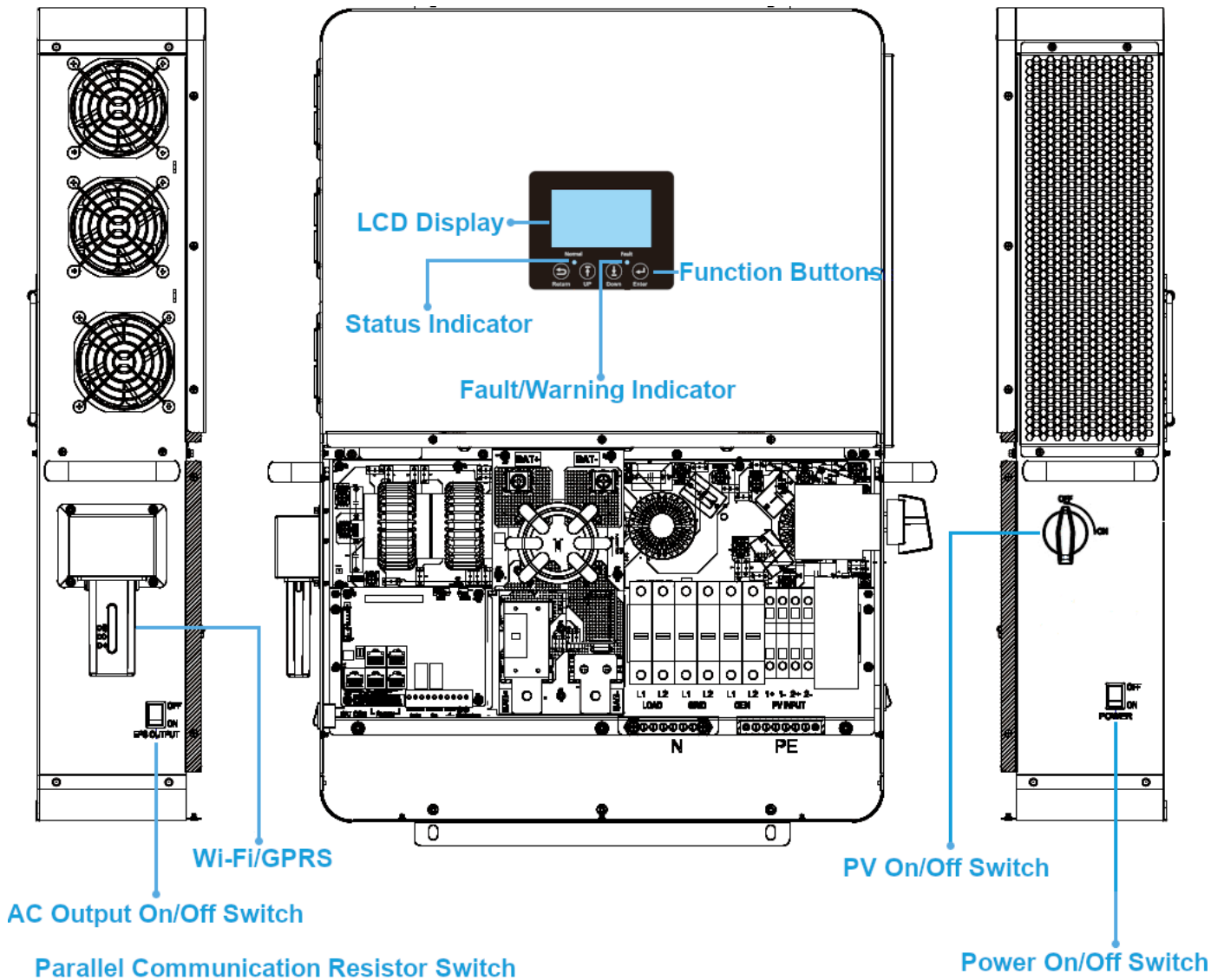



## 4.2 INVERTER INTERFACE

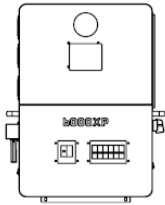
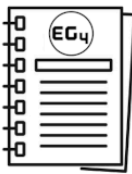

## 5. INSTALLATION

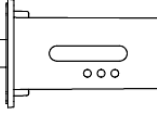
### 5.1 PACKING LIST

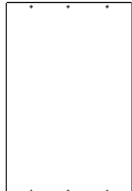
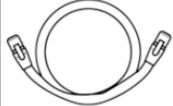
When the product is unpacked, the contents should match those listed below:

 6000XP Inverter	 User Manual	 (6) Expansion Bolts	 (1) Wi-Fi Module
 Cross-head bolts (2) M8 Flange Nut (4) M3 x 10	 (1) Mounting Template	 (1) Inverter to Battery communication cable (78 in.)	 (1) Inverter to Inverter parallel cable (78 in.)

Pictures are for reference only.

### 5.2 LOCATION SELECTION AND INSTALLATION

1. The mounting wall should be strong enough to bear the weight of the inverter.
2. Please maintain the minimum clearances presented below for adequate heat dissipation.
3. The inverter should be installed upright on a vertical surface.

#### Inverter Spacing Diagram

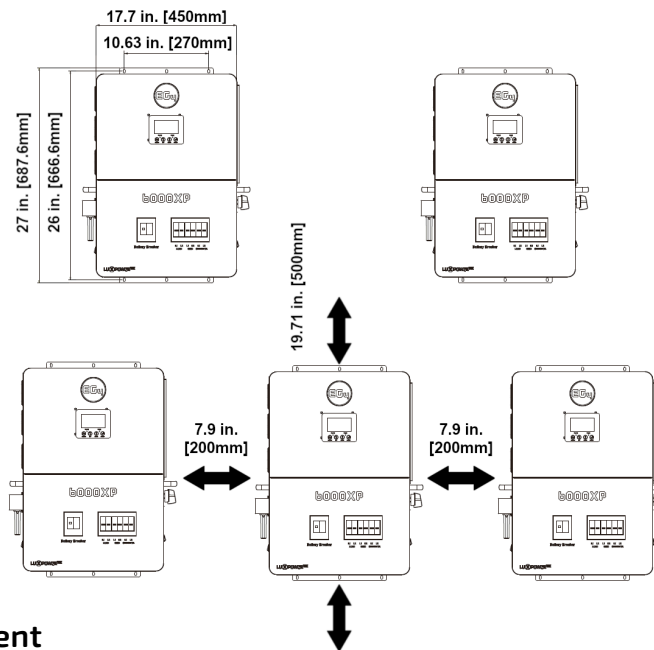

#### Inverter Angle Placement

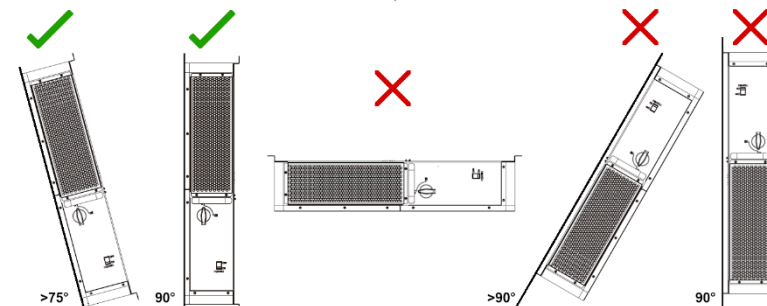

## 5.3 STORAGE INFORMATION

If placing the inverter into storage before installation, please keep the following factors in mind when selecting a storage location.

1. The inverter and its components must be stored in its original packaging.
2. The storage temperature should remain within 5 – 140°F (-15 – 60°C), and humidity within 0-85%.
3. The package should remain upright.
4. **Do not** store the inverter or its packaging in direct sunlight or where there is potential for water to accumulate.
5. See diagram below for an example.

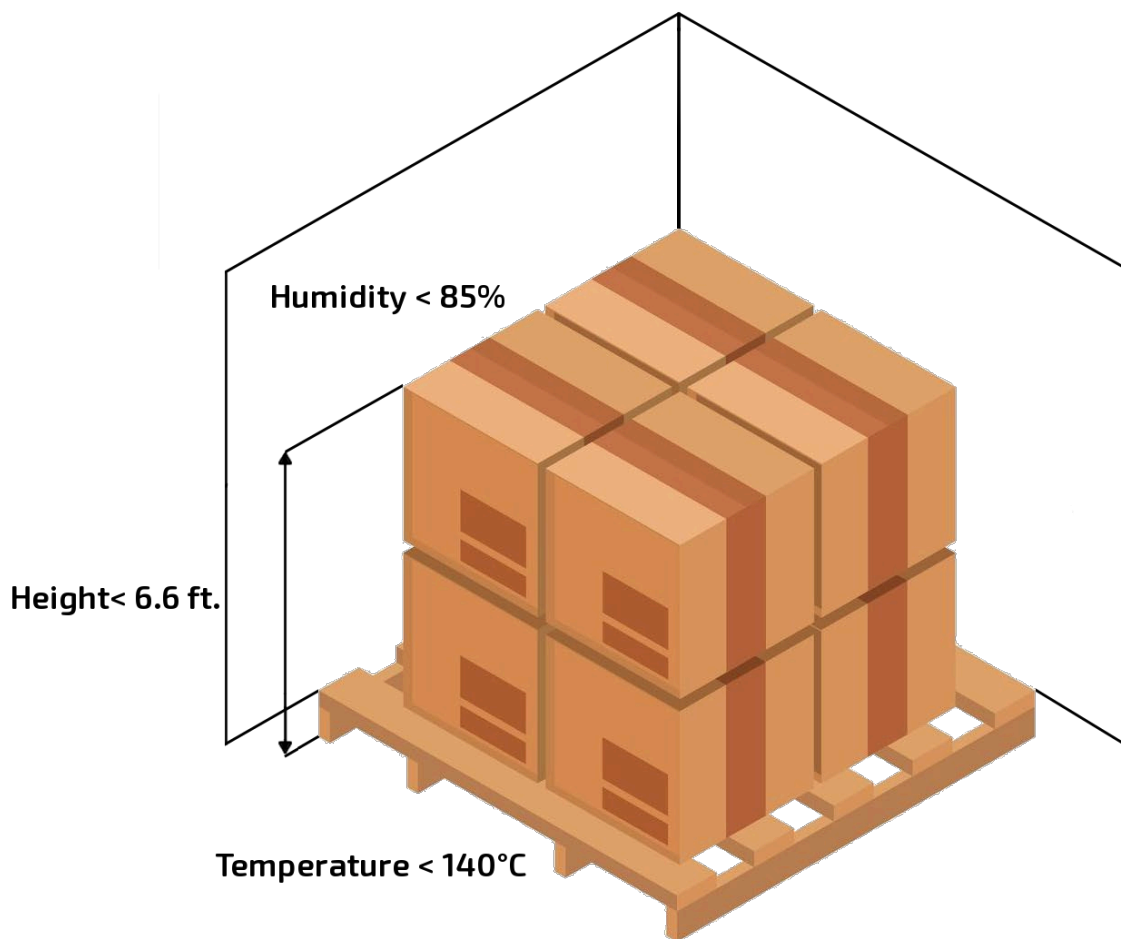

## 5.3.1 INSTALLING THE INVERTER

The inverter is designed to be wall-mounted and should be installed on a vertical, solid, mounting surface, such as brick, concrete, or other **non-combustible** material. Two or more people may be needed to install the inverter due to its weight ( $\approx 53$  lbs.).

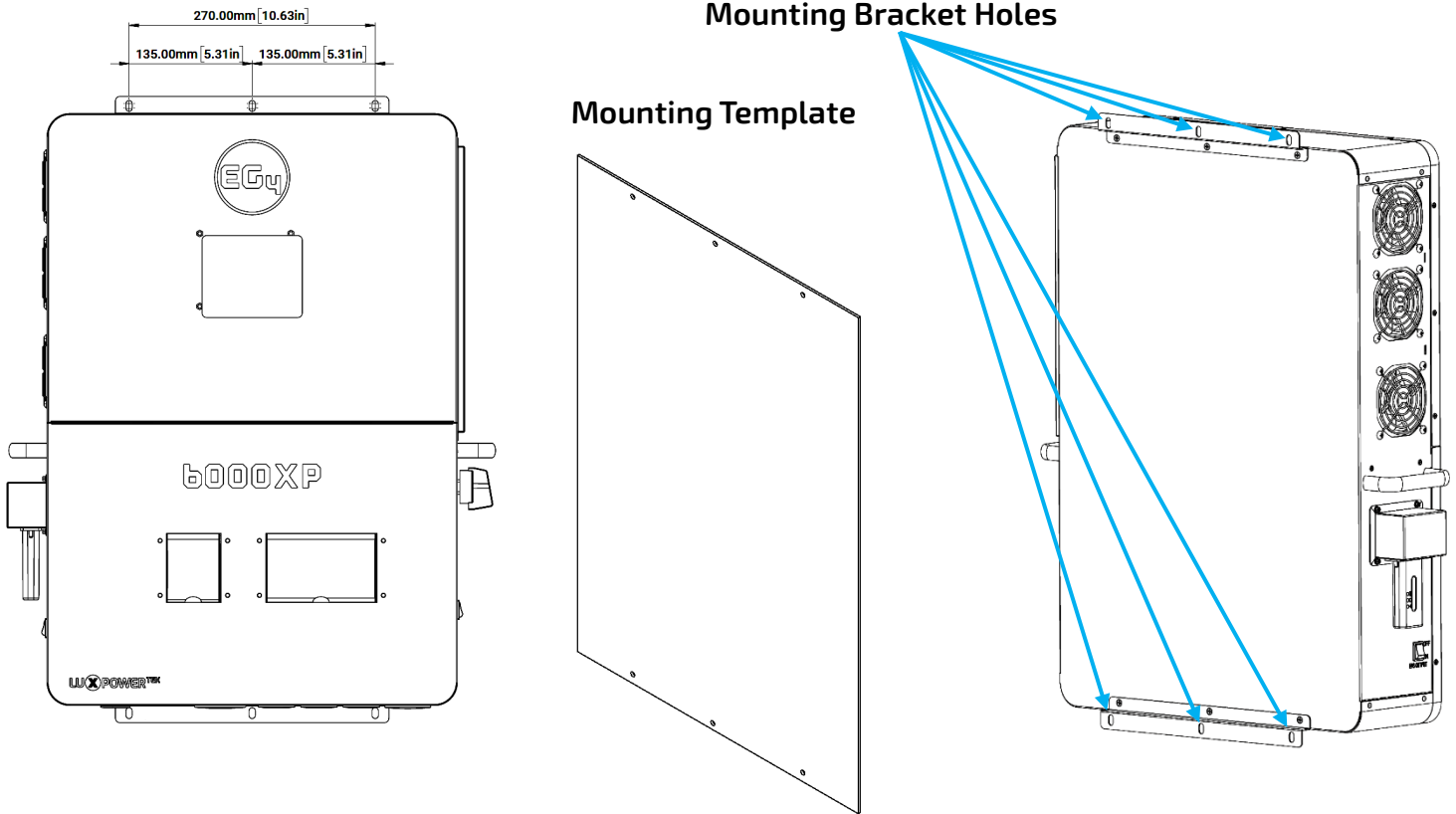

### NOTE:

**Ensure the surface the inverter is being mounted to is able to support the weight of the unit and has proper spacing as per the diagram on the previous page.**

#### Mounting Steps

1. Identify where the inverter's final placement will be.
2. Use the included cardboard template to mark where the mounting screws will be installed.
3. Using a ruler, ensure the top left to top right marks are  $\approx 10.63$ in. apart, along with the bottom left to bottom right marks.
4. Using a ruler, ensure the top left to bottom left marks are  $\approx 26.2$ in., along with the top right to bottom right marks.
5. Place the inverter over the holes to ensure they line up with the bracket plate. Upon confirmation, proceed to the next step.
6. Drill 5/16 in. (8 mm) diameter holes on the marks, making sure the holes are deeper than 2 in. (50 mm).
7. Insert the expansion bolts into the drilled holes.
8. Use the corresponding nuts and washers (packaged together with the expansion bolts) to install and affix the inverter onto the wall. Use the team-lift technique to ensure the users' safety.

## 5.4 CONNECTION OVERVIEW

### 5.4.1 SYSTEM CONNECTIONS

Before connecting wiring, please remove the bottom cover by removing the 7 screws as shown below.

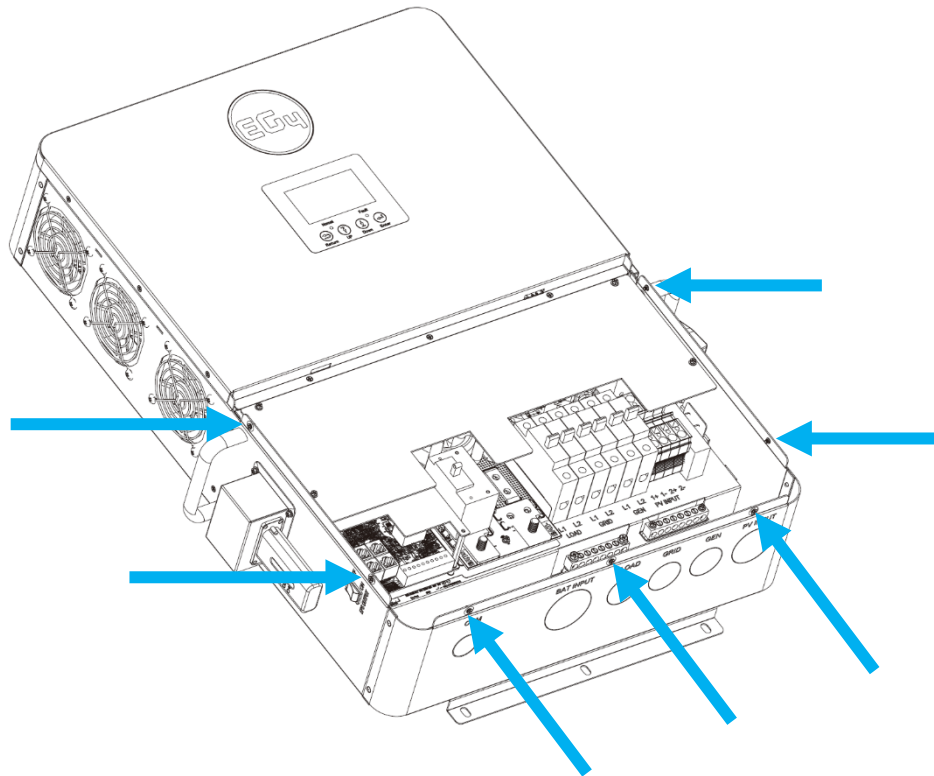

## 5.5 PV CONNECTION

### 5.5.1 CONNECTING PV TO THE INVERTER

Install a separate DC circuit breaker/isolator between the inverter and PV module(s). The recommended DC breaker is a 4-pole 600V/20A, which is the minimum sized isolator switch to house both positives and both negatives if using two independent strings. If only using 1 string, a 2 pole 600V/20A isolator/breaker is recommended. The recommended cable size for the PV connection(s) is 10 AWG (4mm<sup>2</sup>) torqued to 10.6 in-lbs. (1.2 Nm).

Consult with the installer to ensure that appropriate cable sizing is used due to various factors such as voltage drop and Voc.

PV Cable Size	Min. PV Disconnect/Isolator Spec	Torque Specs
10 AWG – 6 AWG (Max) (6mm <sup>2</sup> - 16mm <sup>2</sup> )	600V/20A	10.6 in-lbs. (1.2 Nm)



## REMINDER

Verify the lowest ambient temperature of the installation location. The rated Voc on the solar module nameplate is obtained at STC (Standard Testing Conditions = 77°F/25°C). As the ambient temperature drops, the solar module Voc increases. Please ensure the maximum solar string voltage, corrected at the lowest temperature, **does not exceed** the inverter's maximum input voltage of 480VDC.

PV Input Data	Description	Parameter
DC Input Voltage Range	Range required for the unit to operate up to max input	100–480VDC
Load Output Minimum Voltage	Minimum voltage needed to output power on Load side	>140VDC
MPP Operating Voltage Range	Range where the MPPT can track	120–385VDC
Nominal MPPT Voltage	The MPPT will operate most optimally at this voltage	320VDC
Nominal MPPT Amperage	The MPPT will operate most optimally at this amperage	17A
Maximum MPPT Amperage	The MPPT can accept up to this amperage (clipping will occur past this value)	25A
Maximum Utilized Solar Power	Wattage the unit can utilize from array after considering all power loss factors	8kW

### 5.5.2 STRING SIZING

When solar modules are put in a series string, the voltage multiplies times the number of modules and the amperage stays the same as each module.



#### NOTE:

**Each MPPT is rated for 4kW of solar input which leads to 8kW PV input in total. Size the PV strings accordingly for maximum gain.**

**For example:** Using solar modules that have a 40VDC Voc (@77°F) with a Max Power amperage of 10 Amps (Imp) - 10 modules wired in a series string would have a Voc of 400VDC (@77°F) and a string amperage of 10 Amps. When the temperature lowers, the voltage can rise above the maximum allowed by the inverter and damage will result.

*To determine how many modules per string; first verify the lowest possible ambient temperature of the installation location. Next, find the rated Voc, Vmp, Isc and Imp of the solar module at 77°F and the temperature coefficients for voltage and power. Then, calculate highest possible Voc for the entire string when the ambient temperature falls to the lowest possible ambient temperature upon sunrise. To make this calculation, use a string calculator or consult a solar designer or solar electrician.*



**CAUTION! FOR ALL MODULES, THE CALCULATIONS NEED TO BE PERFORMED OR VERIFIED BY USING A STRING CALCULATOR OR CONSULTING A PROFESSIONAL.**

Finally, calculate the maximum current of the string (Isc) so as not to exceed the inverter's MPPT circuit ratings of 25A (see note at end of section). Double check if the calculated Vmp



**DANGER: Damage WILL occur if the string voltage exceeds the inverter's maximum input voltage of 480VDC!**

range is within the 120-385VDC optimal MPPT circuit operating range. It is recommended to consult a solar designer for assistance.

The inverter has two MPPT PV charging circuits. MPPT #1 and #2 will utilize up to 17 amps, which means two strings can be paralleled for any modules having less than 8.5A ( $I_{mp}$ ) rating.

When sizing strings for each MPPT, they **MUST** be the same model, brand and # per string (series and parallel).

All panels on a series/parallel string should face the same orientation and be exposed to roughly the same shading across the string. Consideration should be placed on string location and wiring order on the racking to minimize shading effects. One shaded module will disproportionately reduce the output of the entire string. This can be mitigated by avoiding linear strings in favor of rectangular strings, or by the use of string optimizers.



**NOTE:** The array may have a higher  $I_{mp}$  than the 17A specified, but the MPPTs may not make full use of the extra current which could lead to component deterioration over time.

### 5.5.3 PV WIRING INSTRUCTIONS



#### **WARNING:**

*Please follow the steps listed below to ensure proper PV connections.*

**Step 1:** Before installing PV wiring into the inverter, please ensure all breakers and disconnects are open (off) and confirm the PV strings are not energized by using a multimeter to ensure there is no DC voltage on the lines. Once that has been verified, please proceed to step 2.

**Step 2:** Strip off 1/4 - 5/16 in. (6 – 8mm) insulation from the PV strings' positive and negative conductors.



**NOTE:** If using fine stranded wire, use ferrules to secure the connections to the inverter

**Step 3:** Insert the conduit fitting into the openings for the PV connections and tighten from the inside using the counter nut.

**Step 4:** Route the PV conductors through the conduit fitting and into the inverter.

**Step 5:** Secure the PV conductors in place into their respective terminals and torque to 10.6 in-lbs. (1.2 Nm). Verify the cables are secure by lightly tugging on them.

**Step 6:** Ensure the conduit and conduit fittings are fastened reliably, and the cable entry holes are sealed.

**Please see diagram below for PV terminal labeling:**



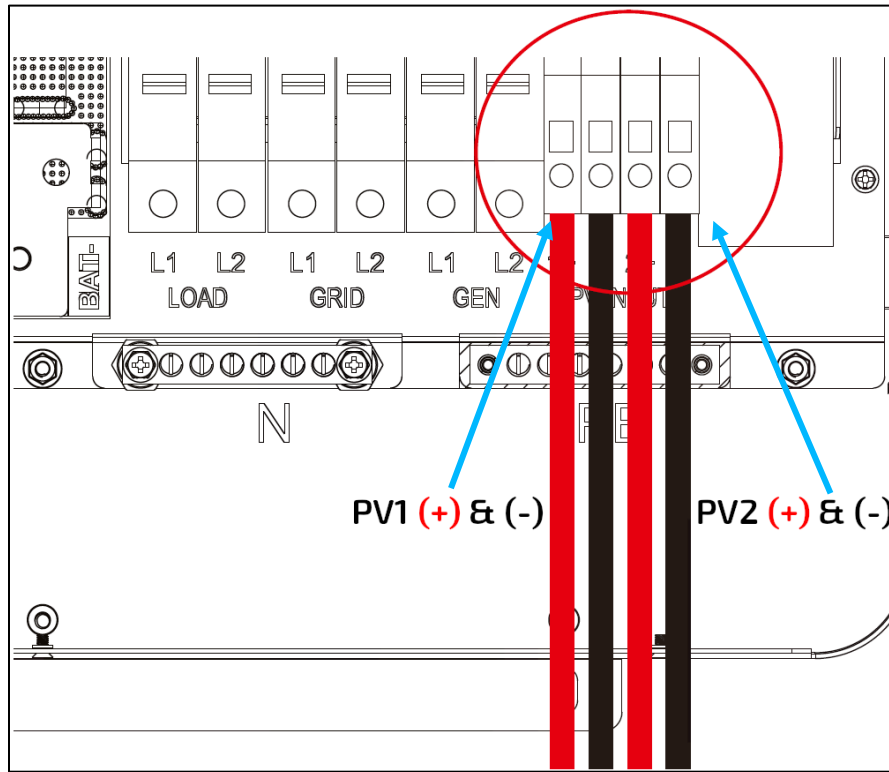

**NOTE:** All exposed metal parts of the system must be grounded regardless of voltage, including solar panel frames.

***DO NOT GROUND NEGATIVE PV LINES, ONLY SOLAR PANEL FRAMES!***

## 5.6 BATTERY CONNECTION

The EG4 6000XP can utilize either Lithium or Lead-Acid batteries. There is a combination of settings that need to be configured depending on the battery type.



**NOTE: For Lead-Acid batteries, the recommended charge current is 0.2C**

### 5.6.1 BATTERY CABLE CONNECTION

Follow the steps below to properly connect the battery wires.

**Step 1:** Place all breakers in the open (off) position before connecting or disconnecting wires. Ensure that there is no DC voltage present with a voltmeter.

**Step 2:** Assemble battery ring terminal based on recommended battery cable and terminal size (see table below).

**Step 3:** Connect all batteries as the unit requires.



**NOTE: If using a battery rack, ensure that all battery connections are installed properly before proceeding. Please refer to battery manual for more information.**



**NOTE: The recommended battery capacity of one 6000XP inverter is  $\geq 200\text{AH}$**

**Step 4:** Connect the positive battery cable (Red) to the positive battery terminal (BAT+) and the negative battery cable (Black) to the negative battery terminal (BAT-) with a torque rating of  $\approx 97 - 106$  in-lbs. (11 – 12 Nm) per connection.

**Step 5:** Be sure not to cross-polarize, as this **will damage** the equipment.

The recommended battery cable and terminal size are as follows:

Maximum Amperage	Battery Capacity	Wire Size	Ring Terminal			Torque Value	Terminal Temperature Rating
			Cable (mm <sup>2</sup> )	Dimensions			
				Depth	Length		
140A*	$\geq 200\text{AH}$	1 AWG	38	.25 in. (6.4mm)	1.5 in. (39.2mm)	97 – 106 in-lbs. (11 – 12 Nm)	-40 - +248°F (-40° - +120°C)

**\*Charging Current:** 115A @48VDC (AC), 125A @48VDC (PV)

**\*Discharging Current:** 140A

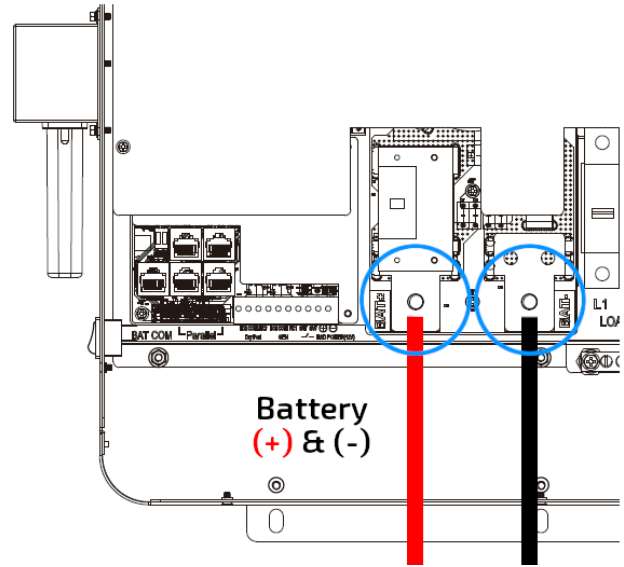

## 5.6.2 LITHIUM BATTERY COMMUNICATIONS

Upon successful installation of the batteries, follow the next steps to enable closed-loop communications (with compatible battery modules) between batteries and inverter.

1. Connect either the CAN or RS485 (depending on make/model of battery) communications cable between inverter and battery. See diagram below.

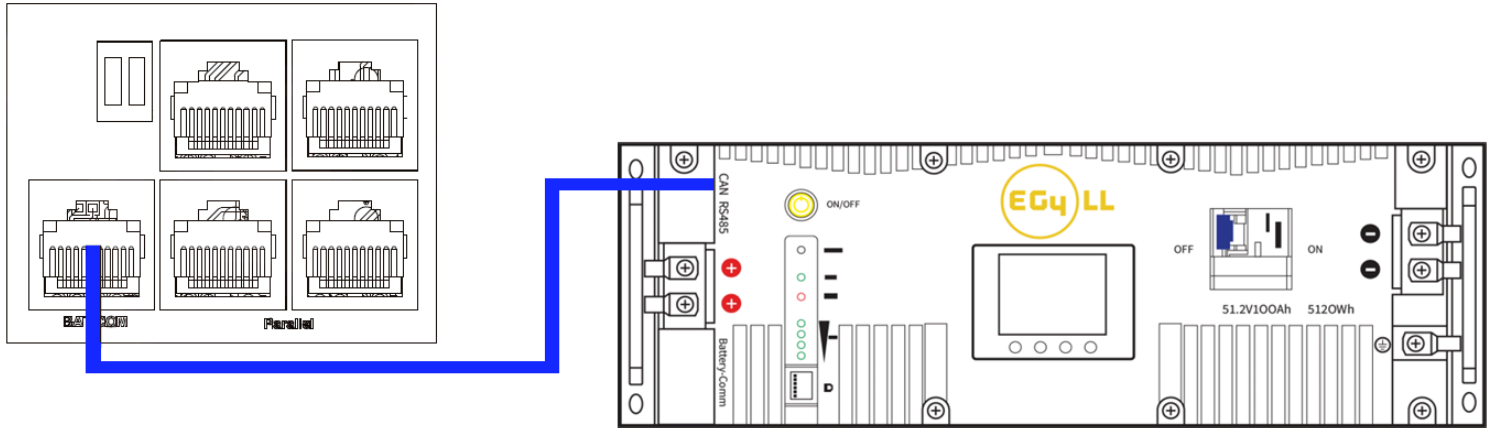

2. For the inverter to communicate with the battery BMS, setting 3 must be changed to “Li-ion”. The inverter will then switch to a secondary setting. Here, select the make/model of battery and press enter to registers the change. For EG4 batteries, select “0” after confirming “Li-ion” as the battery type.



**ATTENTION:** If attempting to BMS communicate with EG4 LifePower4 batteries, an optional firmware update will need to be performed on the batteries.



**NOTE:** If needing to extend the inverter to battery communication cable, or to build a new one, please refer to the following table for the inverter pinout descriptions.

For battery specific pinouts, please refer to the respective battery user manual.

PIN #		1	2	3	4	5	6	7	8
CAN	Pin	X	X	X	BMS_CAN H	BMS_CAN L	X	X	X
RS485	Description	BMS_485 B	BMS_485 A	X	X	X			

## 5.7 AC WIRING INFORMATION

When sizing AC wires, please adhere to the following information.

### AC Cable Requirements:

Terminal Connection	Wire Size	Torque Values
GRID	8 AWG (10mm <sup>2</sup> )	18 in-lbs. (2 Nm)
GEN	8 AWG (10mm <sup>2</sup> )	18 in-lbs. (2 Nm)
LOAD	8 AWG (10mm <sup>2</sup> )	18 in-lbs. (2 Nm)

## Ground-Neutral Bonding

The information below describes the nature of the ground and neutral in the inverter and their relationship to the system. Always consult with the installer or a licensed electrician to ensure that the right configuration is being used:

- The neutral line is a solid connection between AC input and AC output (known as a Common Neutral Architecture).
- The neutral line between the AC input and AC output is never disconnected.
- This architecture assumes there is a single neutral-ground bond in the system. Typically, the neutral-ground bond for a system will be at the first means of disconnect for the grid. However, if there is no neutral-ground bond in the system, the 6000XP can be configured to create the bond internally (*see setting 26*).



**WARNING:** This is not a dynamic bond. It is either always enabled or always disabled.



**NOTE:** Always be sure to connect the AC Output ground wire to the Ground terminal bus (labeled PE in the diagram) first before installing AC Outputs L1 and L2.

### 5.7.1 STEPS FOR AC CONNECTION

Please follow the steps outlined below to ensure proper AC Input/Output connections.

**Step 1:** Before installation of **any** wiring, please ensure all breakers are open (off) before making any connections. Use a multimeter to confirm the AC Input lines (L1, L2 and neutral) are not energized.

**Step 2:** Strip off 5/16-3/8 in. (8-10 mm) insulation from the AC cables.

**Step 3:** Fasten the AC Input wires into their respective terminals using the proper torque ratings.

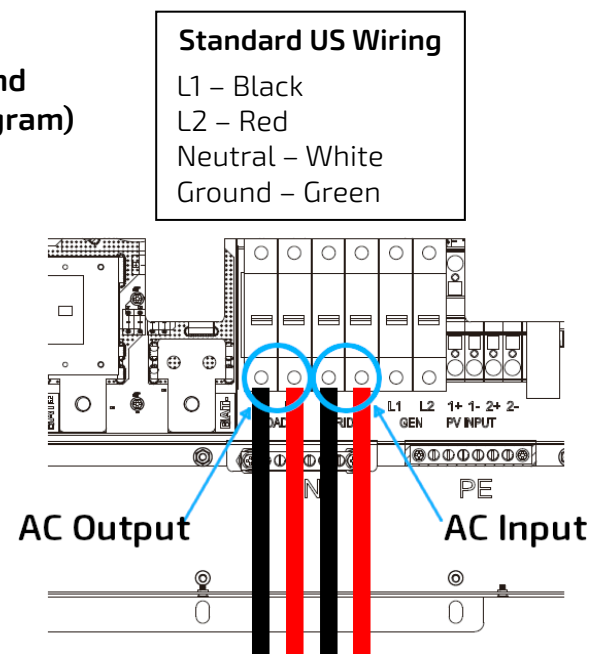

**NOTE:** After connecting all AC wiring, put the built-in LOAD breaker back to the ON position before providing power to the load.

## 5.8 WORKING WITH A GENERATOR

### 5.8.1 GENERATOR SYSTEM CONNECTION

The EG4 6000XP can utilize a generator for backup power in the case of Grid failure. When sizing generators to provide both adequate power and frequency, keep in mind that the THD (Total Harmonic Distortion) of the generator must be <3%. It is a good rule of thumb to size the generator for **at least** 1.5x the output of the inverter to allow for powering loads and charging batteries. The table listed below shows the recommended generator capacity for optimal operations.

Number of Inverters in Parallel	Generator Capacity
1	>10kW
2	>15kW
3	>20kW
4	>25kW

When properly wired and configured, the generator, if compatible with remote start, will start automatically when the battery voltage/SOC is lower than the cut-off value or there is a charge request from the BMS. When the generator is running, it will charge the batteries and excess AC power will be diverted to the AC output (LOAD) to power loads. The pass-through relay on the inverter's generator terminal (GEN) is 50A. When the generator is on, please ensure the total load and charge current does not exceed 50A.

## 5.8.2 INTEGRATED TWO-WIRE START/STOP



This inverter has 2 two-wire start/stop contact connections that can be used to remotely enable external devices such as a generator. The Dry Port (NO2, COM2) can be used to remotely enable an external device when the battery voltage reaches a pre-set warning level. Similarly, the GEN Port (NO1, COM1) can be used to remotely start a generator. To do so, the generator start signal must be connected to the inverter GEN contacts, NO1 and COM1.



**REMINDER:** NO = Normally Open, COM = Common

Dry Port and GEN relay maximum specification: 250VAC, 5A

The following table shows the ports' status under various system conditions.

Inverter Status	Condition		Dry Port Status	GEN Port Status
				
Power Off	Inverter is off and no output is powered		Open	Open
Power On	Without Grid	Battery Voltage/SOC < Generator Charge Start Voltage/SOC	Closed	Closed
		Battery Voltage/SOC > Generator Charge Stop Voltage/SOC	Open	Open
	With Grid	Battery Voltage/SOC < Generator Charge Start Voltage/SOC	Closed	Open
		Battery Voltage/SOC > Generator Charge Stop Voltage/SOC	Open	Open



**NOTE:** If running more than one inverter in the system, the generator must be wired to provide power to every inverter running in parallel for the inverters to function as intended.

## 5.8.3 GENERATOR AC CONNECTIONS

Please follow the steps listed below to ensure the generator connections are properly installed.

**Step 1:** Before making any wiring connections, be sure to have the inverter(s) powered off, the generator powered off, and all circuit breakers open (off) to prevent damage to the unit.

**Step 2:** Properly identify the generator's output lines. By US wiring standards, L1 wire will be black, L2 will be red, Neutral will be white, and ground will be green. Once identified, remove  $\approx 3/8$  in. ( $\approx 10$ mm) from the insulation sleeve on the wires.

**Step 3:** Ground the generator's output ground to the Ground Bus (labelled PE) of the inverter.

**Step 4:** Install L1 to the GEN port's L1 terminal, then install L2 to the GEN port's L2 terminal. Next, fasten the Neutral wire from the generator into the N-BUS (Neutral Bus).

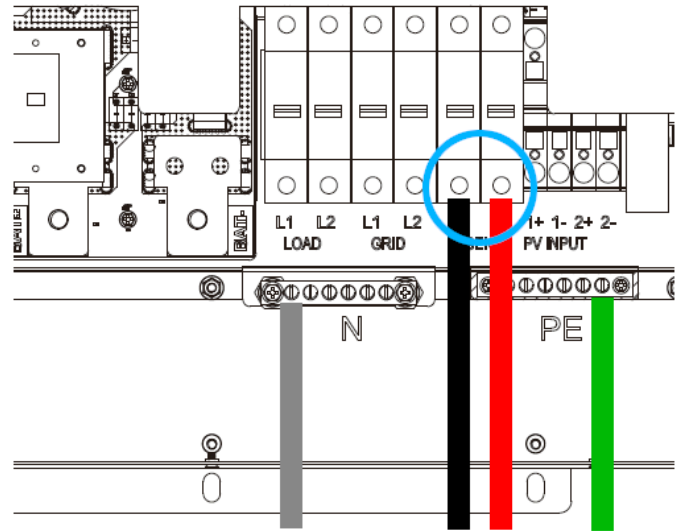

## 5.9 GENERATOR START AND STOP SETTINGS

Using the EG4 Monitoring Software, go to the “Maintenance” page where “Remote Set” will be selected automatically. Scroll to the “Generator Charge” section and select the “Generator Charge Type” (see screenshot below). Normally, lead-acid batteries are charged according to voltage and Lithium batteries are charged according to SOC.

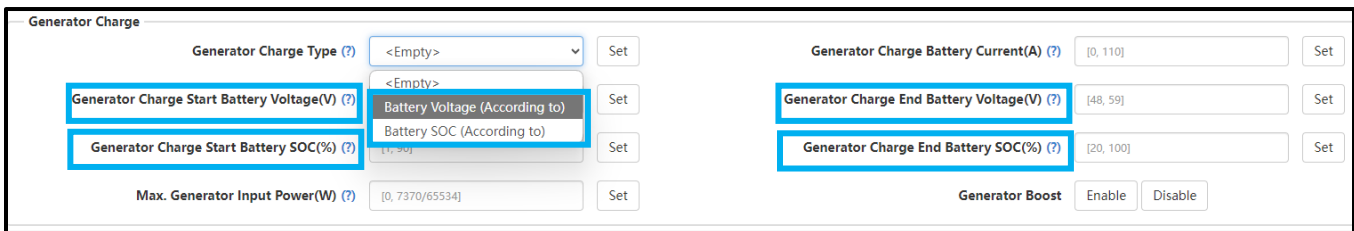

## Generator Start Conditions:

The generator will start when utility fails **and** one of the following conditions is met:

- The battery is discharged to the cut-off setting **or**
- There is a force charge request from battery **or**
- The battery voltage or SOC is lower than the “**Generator Charge Start Battery Volt/SOC**” setting

## Generator Stop Conditions:

When battery voltage or SOC is higher than the “**Generator Charge End Battery Volt/SOC**” settings.

## 5.10 OFF-GRID

The 6000XP Inverter can fully function in off-grid only mode. It does not need the utility or generator to function. Purely off-grid systems that do not have access to the utility should strongly consider having a 2-wire start backup generator for extended cloudy periods (8-12 kW diesel recommended per 6000XP - 8kWs **minimum** per inverter). Off-Grid systems should have robust battery banks sized to ensure multiple days of power and to reduce generator run time.

### 5.10.1 OFF-GRID WIRING

The 6000XP can accept up to 50 Amps (12kWs) of generator power and will pass through all available power to the loads. Therefore, the loads subpanel can be sized up to the size of the backup generator with 50 Amps minimum per inverter.

## 5.11 AC COUPLING INSTALLATION CONNECTION

AC coupling allows the user to add onto an existing grid tied solar system. PV comes from the existing system while the AC coupled inverter controls battery charging and any extra PV coming into the system. This setting allows the user to still have power off grid. The inverter can accept PV inputs to both MPPT channels and AC coupled solar input simultaneously. The AC coupled solar input can be up to 50A of AC power while the MPPT channels can handle up to 8kW of solar. The existing solar system is connected to the inverter's GEN terminal.

To set AC coupling, ensure the inverter is in standby mode. Then navigate to setting 32 where AC coupling can be enabled and battery voltage or SOC can be set. Take the inverter out of standby mode afterwards.

### After the AC couple function is enabled:

When battery SOC or voltage gets below the set parameters, AC coupling will engage and use PV from the existing solar system to charge the batteries. When the battery bank is charged to the set limit, the inverter will continue to control the loads without charging the battery bank. There will be about a 5-minute delay for AC coupling to turn on.

### AC Coupling Settings:

The “AC couple” setting must be enabled when connecting an existing on-grid system to the GEN terminal.

**Start SOC/Voltage (%/V):** The battery SOC or Voltage at which the AC coupled inverters are turned on (50% to 70% recommended).

**End SOC/Voltage (%/V):** The battery SOC or Voltage at which the AC coupled inverters stop charging batteries (90% recommended).



**NOTE:** It is recommended to keep the Start V/SOC and the End V/SOC within 5 – 10% of each other for optimal operations when utilizing AC Coupling.



**NOTE:** If looking to frequency shift when AC Coupling, it is recommended to set the Start SOC to 99% and the End SOC to 100%.

## 5.12 PARALLELING INFORMATION

### 5.12.1 PARALLEL COMMUNICATION CONNECTIONS

The EG4 6000XP inverter supports parallel connections to expand power and energy capacity to suit different usage scenarios. **Up to 16 units can be paralleled to reach a capacity of up to 96kW.** The parallel communication wiring diagrams are shown below. The bypass switch connects the loads to LOAD panel by default. If the inverters fail, users can switch the loads to utility.

**Please contact the inverter supplier for more detailed guidance on paralleling systems.**



**REMINDER:** Put the CAN communication PIN to ON status for the first and the last inverter and OFF for inverters in between. Both switches in the “ON” position translates to address 1. Both switches in the “OFF” position translates to address 0.

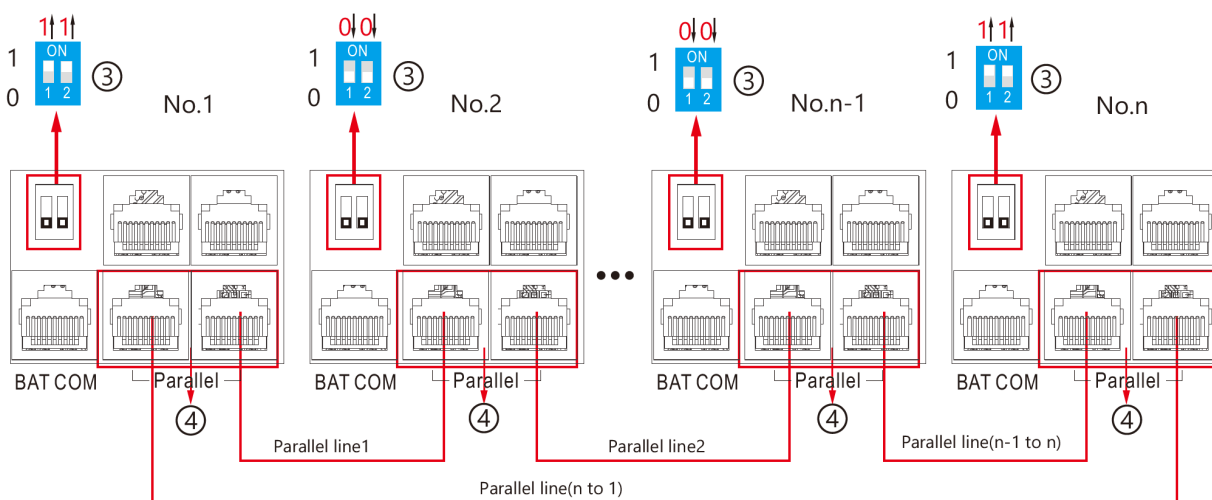

### 5.12.2 PARALLEL CONFIGURATION

#### Important notices for parallel system:

- If utilizing the generator input (GEN), ensure that the generator is connected to all inverters in parallel.
- If it is not possible to evenly divide solar strings per inverter, it is recommended to have more PV strings on the master inverter.
- The values shown on the LCD of each inverter displays the individual inverter’s contribution to the system, **not the system’s total.**



## **Before commissioning:**

1. Verify that all inverters in the system are updated to the latest firmware. Please contact the distributor to confirm the latest version.
2. Make sure the power cables and parallel communications cables have been wired correctly and verify the DIP-switch settings are correct.
3. Ensure the LOAD breakers are off (open). Ensure there is no AC voltage present with a multimeter before proceeding to the next step.
4. Power on the inverters.
5. Navigate to setting Z1 to configure phasing.
6. Starting with the primary inverter (the inverter communicating with the battery bank), change setting Z1 to 1PH for split-phase parallel. The LCD will then switch to a secondary setting, Parallel Phase. Set the inverter to P1 for phase 1. Repeat this step for all paralleled inverters.
7. Enable **“Battery Shared”** on all inverters in parallel.
8. Ensure all inverters are set to **“P1”** phase.
9. Ensure the battery to inverter communications cable is properly connected from master battery to inverter.



**NOTE: If commissioning a single inverter system, ensure setting Z1 is set to NoPL (no parallel) and then finish the commissioning**

### **Commissioning Steps:**

1. Power on the system per the start-up sequence outlined in section 13.
2. Turn on the battery and make sure the communication works on all units.
3. Check the parallel info via the Home page on the LCD.
4. Before connecting loads to the load output terminal, check the output of L1 to N, L2 to N and L1 to L2 to ensure there is no voltage present.
5. Add some small loads to the load output and verify power output.
6. Perform a full system restart as outlined in section 13 to finish the commissioning.



**NOTE: To determine proper host and slave definition of the inverters, provide power to each before turning on. Turn on the EPS Output (AC Output) on the host inverter first, to designate it as host. Power on each inverter paralleled past the host to define them as slaves. On the main inverter display, press “down” three times, then check the numbers & letters in the top left. Host inverter should read “1P-H:P1: 1”, and slave should read “1P-S:P1: “X””, with the “X” representing the number of inverters in parallel.**

## 6. END USER SETTINGS

The EG4 Monitor Software can be used to configure the desired functionality of the 6000XP Inverter. The following sections describe the different fields in the Monitor Software GUI and their definitions for those with an end-user account.

### 6.1 APPLICATION SETTING

- **EPS Voltage Set(V):** Set the voltage of the inverter’s output.
- **EPS Frequency Set(Hz):** Set the frequency of the inverter’s output.

#### AC First

- **AC first Start Time 1, 2, 3:** Set the start time for when inverter passes through from grid to loads.
- **AC first End Time 1, 2, 3:** Set the end time for when inverter passes through from grid to loads.

### 6.2 CHARGE SETTING

**Charge Current Limit(A):** The maximum charge current limitation of the entire system in DC Amps.

#### Lead Acid

- **Charge Voltage(V):** Set bulk charging voltage for Lead Acid batteries.

## AC Charge

- **AC Charge:** Utility charge configuration. If users want to use grid power to charge their battery, they can enable 'AC Charge'. Configure setting by Time, Voltage, SOC, Time & Voltage or Time & SOC. Up to 3 timeslots can be configured via the AC Charge Start Time 1, 2 and 3 settings shown above.
- **AC Charge Battery Current(A):** Set AC Charge Current limit for grid to batteries.
- **AC Charge Start Battery Voltage(V):** Begin charging from grid when batteries reach this voltage. (If set to charge by Voltage)
- **AC Charge End Battery Voltage(V):** Stop charging from grid when batteries reach this voltage. (If set to charge by Voltage)
- **AC Charge Start Battery SOC(%):** Begin charging from grid when batteries reach this SOC%. (If set to charge by SOC)
- **AC Charge End Battery SOC(%):** Stop charging from grid when batteries reach this SOC%. (If set to charge by SOC)

### 6.2.1 GENERATOR CHARGE

- **Generator Charge Type:** Set generator charge type by either Voltage or SOC%.
- **Generator Charge Battery Current(A):** Set maximum amperage charge from generator.
- **Generator Charge Start Battery Voltage(V):** Set Voltage which generator will start charging batteries.
- **Generator Charge End Battery Voltage(V):** Set Voltage which generator will stop charging batteries.
- **Generator Charge Start Battery SOC(%):** Set SOC% which generator will start charging batteries.
- **Generator Charge End Battery SOC(%):** Set SOC% which generator will stop charging batteries.
- **Max. Generator Input Power(W):** Set the maximum power(W) the inverter will pull from generator for charging.
- **Generator Boost:** When enabled, the inverter will pull supplemental power from both PV and battery whenever the generator power is not sufficient to handle the loads.

## 6.3 DISCHARGE SETTING

Discharge Setting

Discharge Control (?) <span style="border: 1px solid gray; padding: 2px;">According to SOC</span> <span style="border: 1px solid gray; padding: 2px;">Set</span>	Discharge Current Limit(Adc) (?) <span style="border: 1px solid gray; padding: 2px;">140</span> <span style="border: 1px solid gray; padding: 2px;">Set</span>
Discharge Cut-off Voltage(V) (?) <span style="border: 1px solid gray; padding: 2px;">42</span> <span style="border: 1px solid gray; padding: 2px;">Set</span>	Discharge Cut-off SOC(%) (?) <span style="border: 1px solid gray; padding: 2px;">15</span> <span style="border: 1px solid gray; padding: 2px;">Set</span>
On Grid EOD Voltage(V) (?) <span style="border: 1px solid gray; padding: 2px;">42</span> <span style="border: 1px solid gray; padding: 2px;">Set</span>	On Grid EOD SOC(%) (?) <span style="border: 1px solid gray; padding: 2px;">15</span> <span style="border: 1px solid gray; padding: 2px;">Set</span>

- **Discharge Control:** Set Voltage/SOC to configure stop time for battery discharge.
- **Discharge Current Limit(Adc):** Set the limit of battery discharge current.
- **Discharge Cut-off Voltage(V)/SOC(%):** Set when batteries stop discharging to power loads via Voltage/SOC.
- **On Grid EOD Voltage(V)/SOC(%):** Set when batteries stop discharging to power loads via Voltage/SOC and switch to have AC power loads/charge batteries. When battery voltage is > (EOD Voltage +3V), the inverter will switch back to battery discharge mode. When battery SOC is > (EOD SOC+10%), the inverter will switch back to battery discharge mode.

## 6.4 AC COUPLE

AC Couple

AC Couple (?) Enable Disable

AC Couple Start Volt(V) <span style="border: 1px solid gray; padding: 2px;">[40, 59.5]</span> <span style="border: 1px solid gray; padding: 2px;">Set</span>	AC Couple Start SOC(%) <span style="border: 1px solid gray; padding: 2px;">[0, 80]</span> <span style="border: 1px solid gray; padding: 2px;">Set</span>
AC Couple End Volt(V) <span style="border: 1px solid gray; padding: 2px;">[42, 80]</span> <span style="border: 1px solid gray; padding: 2px;">Set</span>	AC Couple End SOC(%) <span style="border: 1px solid gray; padding: 2px;">[0, 100]</span> <span style="border: 1px solid gray; padding: 2px;">Set</span>

The inverter supports AC coupling connection with the existing grid-interactive solar system. The existing solar system is connected to the inverter's GEN terminal. Before engaging AC Coupling, the inverter must be in standby mode.

- **AC Couple Start Volt(V)/SOC (%):** AC Coupling will start at this set V/SOC.
- **AC Couple End Volt(V)/SOC (%):** AC Coupling will stop at this set V/SOC.

## 6.5 SMART LOAD

Smart Load

Smart Load (?) Enable Disable

Start PV Power(kW) (?) <span style="border: 1px solid gray; padding: 2px;">[0, 25.5]</span> <span style="border: 1px solid gray; padding: 2px;">Set</span>	Grid Always On (?) <span style="border: 1px solid gray; padding: 2px;">Enable</span> <span style="border: 1px solid gray; padding: 2px;">Disable</span>
Smart Load Start Volt(V) <span style="border: 1px solid gray; padding: 2px;">[40, 59]</span> <span style="border: 1px solid gray; padding: 2px;">Set</span>	Smart Load Start SOC(%) <span style="border: 1px solid gray; padding: 2px;">[0, 100]</span> <span style="border: 1px solid gray; padding: 2px;">Set</span>
Smart Load End Volt(V) <span style="border: 1px solid gray; padding: 2px;">[40, 59]</span> <span style="border: 1px solid gray; padding: 2px;">Set</span>	Smart Load End SOC(%) <span style="border: 1px solid gray; padding: 2px;">[0, 100]</span> <span style="border: 1px solid gray; padding: 2px;">Set</span>

- **Smart Load Enable/ Disable:** When the smart load function is enabled, the GEN terminal is reused to Smart Load, and the inverter will offer power to this load based on the setup values.
- **Start PV Power (kW):** This is the minimum PV power limit to function with smart load output.
- **On Grid Always On:** Once this function is enabled, smart load will always function when grid power is on.
- **Smart Load Start SOC (%) / Volt (V):** The high limit for battery bank to turn on smart load.
- **Smart Load Stop SOC (%) / Volt (V):** The low limit for battery bank to turn off smart load.



**NOTE:** Smart load can only be enabled and disabled through the monitor center website/ app.

## 6.6 RESET



- **Reset:** Reset all settings to factory default. Be sure to keep track of what changes need to be made before powering the system back on!

## 7. INSTALLER SETTINGS

The EG4 Monitor Software can be used to configure the desired functionality of the 6000XP Inverter. The following sections describe the different fields in the Monitor Software GUI and their definitions for those with Installer account access.

### 7.1 COMMON SETTING

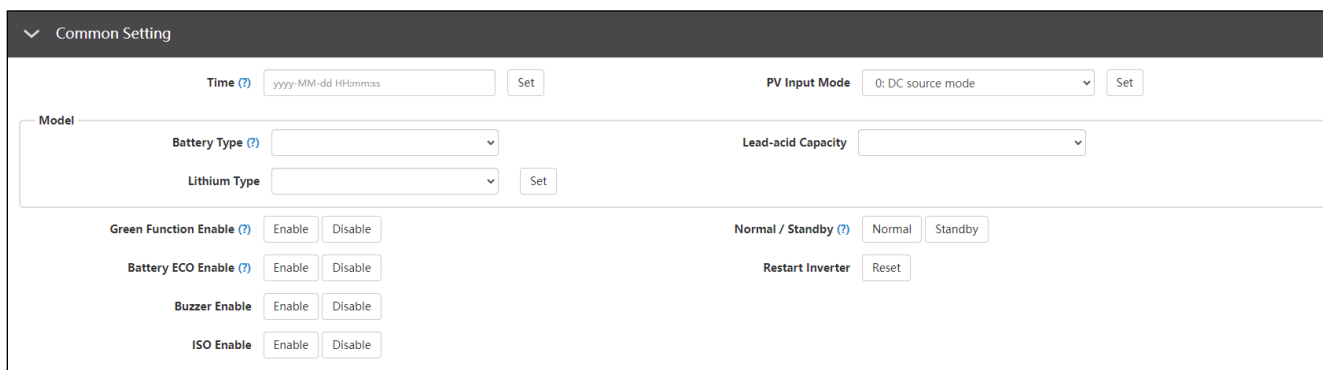

- **Time:** This is the local date and time.
- **PV Input Mode:** This allows the user to select the PV source for the Inverter. This can be: 0: DC source mode, 3: Two MPPT connects to same string, or 4: Two MPPT connects to different string.
- **Battery Type:** The type of battery being used. Can be set to - 0: No Battery, 1: Lead-acid, or 2: Lithium.



**REMINDER: It is not recommended to run the system without battery backup.**

- **Lead-acid Capacity:** Select the total battery capacity for lead-acid banks.
- **Lithium Type:** This setting allows the user to select from a list of compatible batteries for closed-loop communications.
- **Green Function Enable:** When enabled, if the inverter load reading is less than 60W for more than 10 minutes, the inverter output will be cut off.
- **Normal / Standby:** Select Normal for the inverter to operate normally. Select Standby to halt all power input and output.
- **Restart Inverter:** This restarts the inverter.
- **Battery ECO Enable:** When enabled, the inverter will switch to bypass mode if the battery has reached the On-Grid EOD value and AC charging is disabled. The inverter will stay in bypass mode until the battery is being charged again. Switch time can be up to 15ms.
- **Buzzer Enable:** Enable/disable the alarm buzzer.
- **ISO Enable:** Enable/disable PV ground fault circuit interrupter.

Application Setting

EPS Voltage Set(V) (?) 200/100 Set      EPS Frequency Set(Hz) (?) <Empty> Set

AC Input Range (?) <Empty> Set      PV Grid Off (?) Enable Disable

PV Arc Enable Disable      PV Arc Fault Clear Clear

RSD Enable Disable      N-PE Bond (?) Enable Disable

AC First (?)

AC first Start Time 1 (?) [0, 23] : [0, 59] Set      AC first Start Time 2 [0, 23] : [0, 59] Set      AC first Start Time 3 [0, 23] : [0, 59] Set

AC first End Time 1 (?) [0, 23] : [0, 59] Set      AC first End Time 2 [0, 23] : [0, 59] Set      AC first End Time 3 [0, 23] : [0, 59] Set

Parallel Settings

Set System Type (?) <Empty> Set      Battery Shared (?) Enable Disable

Set Composed Phase (?) <Empty> Set



**NOTE:** The user must also establish the paralleling scheme using Setting 21 in the user interface. ‘NoPL’ (Not Parallel) or ‘1PH’ (Single Phase). See Section 12, LCD Settings, for more details.

## 7.2 APPLICATION SETTING

- **EPS Voltage Set(V):** Set the inverter’s output voltage.
- **EPS Frequency Set(Hz):** Set the inverter’s output frequency.
- **AC Input Range:** Set the voltage range for AC Input.
- **PV Grid Off:** If the customer wants the system to have Off-Grid functionality without having battery backup, please enable PV Grid Off. Note that in this situation the AC Output power is supplied by solar and is not stable due to fluctuating voltages from the solar modules. We suggest the customer install battery/batteries to keep the inverter output voltage stable if they want to have Off-Grid function. (Allows system to access the Off-Grid mode when only solar input is available without battery storage).
- **PV Arc:** Enables detection of arcs on the PV input circuits to the inverter and provides protection from PV circuit arcs.
- **PV Arc Fault Clear:** Clears any fault detected due to arcs on the PV input circuit to the inverter.
- **RSD:** Enables the Rapid Shut Down feature.
- **N-PE Bond:** Enable for the AC Neutral (N) and AC Ground (PE) to be bonded.

### AC First

- **AC first Start Time 1-3:** The time at which the Inverter will use only AC to power loads. The range is 00:00 to 23:59.
- **AC first Stop Time 1-3:** The time at which the Inverter will use only AC to power loads. The range is 00:00 to 23:59.

### Parallel Settings

- **Set System Type:** The EG4 6000XP supports paralleling of multiple inverters. If installing in single-phase, set one inverter as “1 Phase Master”. When composing a three-phase system, set one inverter to “3 Phase Master”.
- **Battery Shared:** For parallel systems, if all inverters connect to same battery bank, Battery Shared must be enabled. The inverter with battery to inverter communication cable connected will broadcast the battery info to all other inverters.

- **Set Composed Phase:** If the system is connected to the grid, the inverter will detect the phase it connects to automatically, record it and output the phase as it detected. If the user setting is different from the phase the inverter detected, it will output the phase detected. The output phase record will be cleared if the customer clears it. If the system is not connected to the grid, the inverter will use the user output phase setting to compose the three-phase output. If the customer sets the wrong phase, i.e., 2 U phase and no W phase, the system will report errors.

## 7.3 CHARGE SETTING

- **Charge Current Limit(A):** The maximum charge current limitation of the entire system in DC Amps.

### Lead Acid

- **Charge Voltage(V):** Set this according to the battery requirements. Range is 50-59VDC.
- **Floating Voltage(V):** Set this according to the battery requirements. Range is 50-56VDC. When using lead-acid batteries, this must be set lower than the 'Charge Voltage' above. When using Lithium batteries in lead-acid mode, this can be set  $\leq$  'Charge Voltage' above.
- **Equalization Voltage(V):** Range is 50-59VDC for lead-acid batteries. When using Lithium batteries in lead-acid mode, this should be set to 0 (zero).
- **Equalization Period(Days):** Range is 0-365 days for lead-acid batteries. When using Lithium batteries in lead-acid mode, this should be set to 0 (zero).
- **Equalization Time(Hours):** Range is 0-24 hours for lead-acid batteries. When using Lithium batteries in lead-acid mode, this should be set to 0 (zero).

### AC Charge

- **AC Charge Based On:** If using AC to charge the battery; the customer must first select the method of charging. This can be set to charge by "Time", "Voltage", "SOC", "Battery Voltage and Time" or "Battery SOC and Time".
- **AC Charge Battery Current(A):** Set this according to the battery requirements. Range is 0-100 Amps.
- **AC Charge Start Time 1-3:** Start AC Charging according to these time settings.
- **AC Charge End Time 1-3:** Stop AC Charging according to these time settings.

- **AC Charge Start Battery Voltage(V):** Battery Voltage at which system will start charging batteries from AC. Set this according to the battery requirements. Range is 38.4-57VDC.
- **AC Charge End Battery Voltage(V):** Battery Voltage at which system will stop charging batteries from AC. Set this according to the battery requirements. Range is 48-59VDC.
- **AC Charge Start Battery SOC(%):** Battery% SOC at which system will start charging batteries from AC. Set this according to the battery requirements. Range is 0-90%.
- **AC Charge End Battery SOC(%):** Battery% SOC at which system will stop charging batteries from AC. Set this according to the battery requirements. Range is 20-100%.

## Generator Charge

- **Generator Charge Type:** Set Generator charging according to Battery Voltage or Battery SOC.
- **Generator Charge Battery Current(A):** Set Generator battery charging current. Range is 0-60 Amps.
- **Generator Charge Start Battery Voltage(V):** Battery Voltage at which system will start charging batteries from the Generator. Set this according to the battery requirements. Range is 38.4-57VDC.
- **Generator Charge End Battery Voltage(V):** Battery Voltage at which system will stop charging batteries from the Generator. Set this according to the battery requirements. Range is 48-59VDC.
- **Generator Charge Start Battery SOC(%):** Battery% SOC at which system will start charging batteries from the Generator. Set this according to the battery requirements. Range is 0-90%.
- **Generator Charge End Battery SOC(%):** Battery% SOC at which system will stop charging batteries from the Generator. Set this according to the battery requirements. Range is 20-100%.
- **Max. Generator Input Power(W):** The inverter will limit the power from the generator to 90% of the total generator capability to prevent overloading. Range is 0-7,370 Watts for a single inverter and 0-65,534 Watts for parallel inverters.
- **Generator Boost:** When enabled, the inverter will pull supplemental power from both PV and battery whenever the generator power is not sufficient to handle the loads.

## 7.4 DISCHARGE SETTING

The screenshot shows the 'Discharge Setting' interface with the following parameters and values:

Parameter	Value	Action
Discharge Control (?)	According to Voltage	Set
Battery Warning Voltage(V) (?)	40.50	Set
Discharge Cut-off Voltage(V) (?)	40.50	Set
On Grid EOD Voltage(V) (?)	40.56	Set
Discharge Current Limit(Adc) (?)	0.110/4480	Set
Battery Warning SOC(%) (?)	0.90	Set
Discharge Cut-off SOC(%) (?)	0.90	Set
On Grid EOD SOC(%) (?)	0.90	Set

- **Discharge Control:** Set to 'According to Voltage' when using a lead-acid battery or a Lithium battery in lead-acid mode. Set to 'According to SOC' when using a compatible Lithium battery.
- **Discharge Current Limit(Adc):** Set this according to the battery requirements. Range is 1-110 Amps for a single battery and 1-4480 Amps for paralleled batteries.
- **Battery Warning Voltage(V):** Set this according to the battery requirements. The inverter will display a battery low warning when the battery voltage falls to this value. Range is 40-56VDC.



- **Battery Warning SOC(%):** Set this according to the battery requirements. The inverter will display a battery low warning when the battery SOC falls to this value. Range is 0-90%.
- **Discharge Cut-off Voltage(V):** Set this according to the battery requirements. Range is 40-56VDC.
- **Discharge Cut-off SOC\*(%):** Set this according to the battery requirements. Range is 0-90%.



**NOTE: \* It is recommended while using EG4 batteries to set this value no lower than 20% to maintain the 80% depth of discharge.**

- **On Grid EOD Voltage(V):** The inverter will stop discharging the battery at this voltage and will use AC to power loads. When battery voltage is > (EOD Voltage +3V), the inverter will switch back to battery discharge mode.
- **On Grid EOD SOC(%):** The inverter will stop discharging the battery at this SOC and will use AC to power loads. When battery SOC is > (EOD SOC+10%), the inverter will switch back to battery discharge mode.

## 7.5 AC COUPLE

**AC Couple**

AC Couple (?)

AC Couple Start Volt(V) [40, 59.5]  AC Couple Start SOC(%) [0, 80]

AC Couple End Volt(V) [42, 80]  AC Couple End SOC(%) [0, 100]

- **AC Couple Enable/Disable:** When there is an existing On-Grid PV inverter, and the 6000XP system needs to function in both On-Grid and Off-Grid mode, connect the AC output of the existing On-Grid PV inverter to the GEN terminal of the 6000XP and enable the AC Couple function.
- **AC Couple Start Volt(V)/SOC (%):** AC Coupling will start at this set Voltage/SOC.
- **AC Couple Stop Volt(V)/SOC (%):** AC Coupling will stop at this set Voltage/SOC.

## 7.6 SMART LOAD

**Smart Load**

Smart Load (?)

Start PV Power(kW) (?) [0, 25.5]  Grid Always On (?)

Smart Load Start Volt(V) [40, 59]  Smart Load Start SOC(%) [0, 100]

Smart Load End Volt(V) [40, 59]  Smart Load End SOC(%) [0, 100]

- **Smart Load Enable/ Disable:** When the smart load function is enabled, the GEN terminal is reused to Smart Load, and the inverter will offer power to this load based on the setup values.
- **Start PV Power (kW):** This is the minimum PV power limit to function with smart load output.
- **On Grid Always On:** Once this function is enabled, smart load will always function when grid power is on.
- **Smart Load Start SOC (%) / Volt (V):** The high limit for battery bank to turn on smart load.
- **Smart Load Stop SOC (%) / Volt (V):** The low limit for battery bank to turn off smart load.



**NOTE: Smart load can only be enabled and disabled through the monitor center website/ app.**

## 7.7 OTHER SETTING

Other Setting

Batt Volt Sample Disable

Fan 1 Max Speed(%)   Fan 2 Max Speed(%)

- **Batt Volt Sample Disable:** Set to Internal, External or Both Available.
- **Fan 1 Max Speed(%):** This sets cooling fan 1 max. speed. Range is 50-100%.
- **Fan 2 Max Speed(%):** This sets cooling fan 2 max. speed. Range is 50-100%.

## 7.8 RESET

Reset

- **All to Default:** This resets all settings to factory default values.



**NOTE:** Be sure to keep track of the settings and what changes need to be made before outputting power from the inverter

## 8. MONITOR SYSTEM SETUP

### 8.1 WI-FI/4G/LAN DONGLE CONNECTION

A Wi-Fi/4G/LAN dongle can be used to monitor the inverter and remotely view the monitoring data on a computer or smart phone. This module can be attached by plugging it in to the 'Wi-Fi' connector on the inverter and securing it with the 4 Phillips head screws. See section 10 for more details regarding dongle setup.

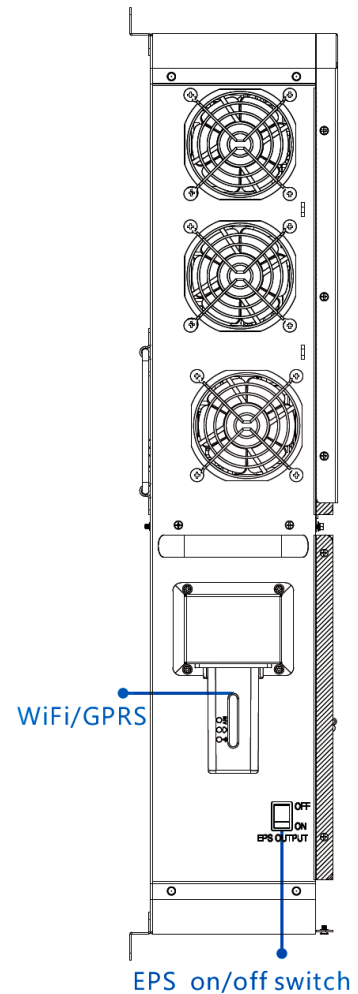

### 8.2 THIRD-PARTY RS485 COMMUNICATION

Meters 485B and 485A can be used when a meter is not connected. These two pins can be used to communicate with the inverter using the RS485 Modbus protocol.

INV485: This interface is shared with the Wi-Fi module. If the Wi-Fi module is not in use, this interface can be used to communicate with the inverter.

Please contact the distributor to get the Modbus protocol for third-party app development.

#### **View data on smart phone:**

A QR code with a link to our website with app installation steps can be found on the side of the inverter or visit our downloads page at [www.eg4electronics.com](http://www.eg4electronics.com) for more information.

## 8.3 ONLINE MONITORING SYSTEM USER INTERFACE

The customer needs to register a monitor account in the monitor system and set a Wi-Fi password for the Wi-Fi dongle before using the EG4 monitor system. The monitoring system may change due to updates, so the following UI descriptions may vary from the current pages on the site. Please contact support@eg4electronics.com to create distributor or installer accounts. See section 10 for detailed instructions on how to access the EG4 Monitor App, how to register an account, and how to set a Wi-Fi password.

### 8.3.1 DASHBOARD (MONITOR TAB)

Once the account is created and the user is logged in, the main page (Monitor tab) of the interface will be displayed.

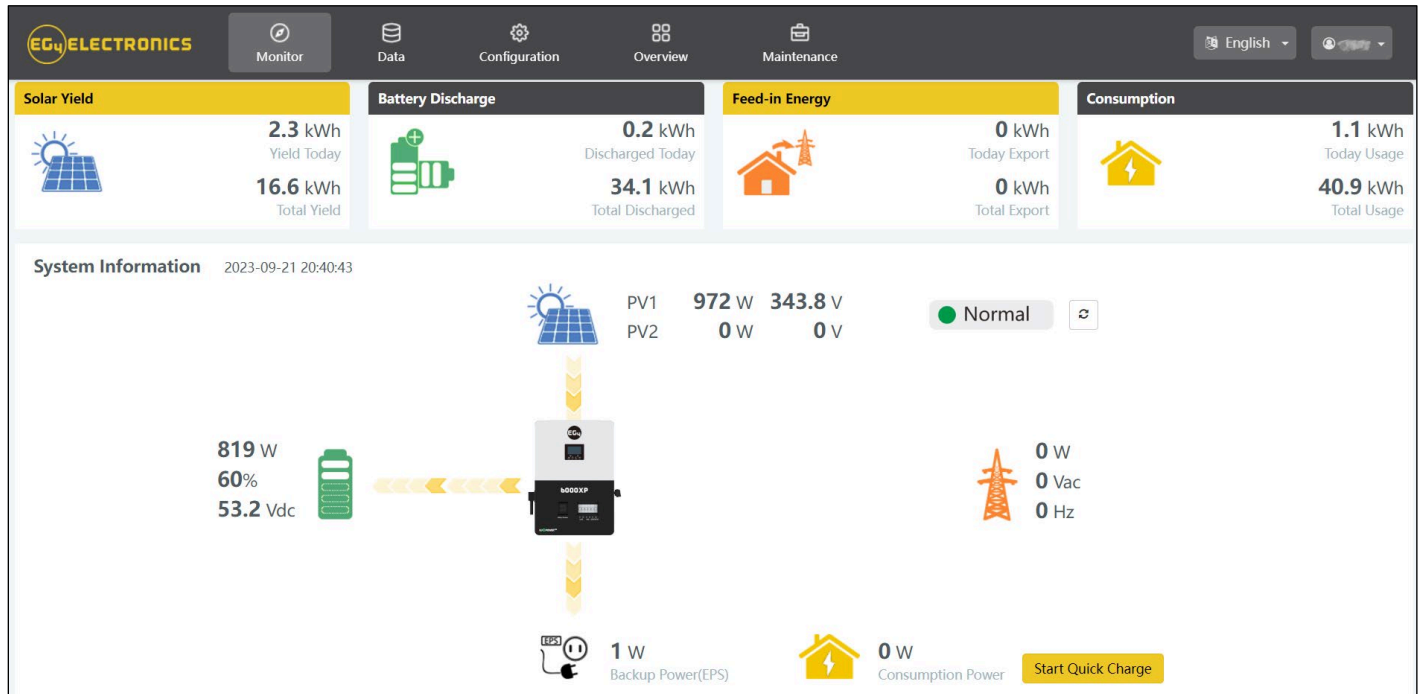

Name	Description
<b>Select station first</b>	<p>Select which station to view, and then select which unit/dongle to view by choosing a serial number from the dropdown list.</p> <p><b>Note:</b> Unchecking the box will only display serial numbers linked to the account.</p>
<b>Solar Yield</b>	<p>Shows power generated by the solar panels (for AC coupled inverters it shows the power generated by the on-grid inverter). The PV CT clamp will have to be installed to be able to show the data correctly. When the picture of the solar yielding is clicked, it will display how the solar energy has been used that day. A second click will show the totals since commissioning.</p>
<b>Battery Discharge</b>	<p>Shows the charge and discharge energy from the battery/batteries. When the battery picture is clicked, the display will switch between battery discharging and battery charging, showing totals for that day and since commissioning.</p>
<b>Consumption</b>	<p>Shows the total energy consumption of the property for that day and since commissioning.</p>
<b>System information</b>	<p>Displays power sources and energy flow, voltage, and amperage from lines to loads. Clicking the button beside the status will refresh the information to reflect real time data.</p> <p><b>Note:</b> When the battery's color is yellow or red it means there is a warning or fault with the battery.</p>
<b>GEN Quick Start</b>	<p>Send a start signal to the generator.</p>
<b>Start Quick Charge</b>	<p>Clicking this will direct the inverter to charge batteries faster for <b>one hour</b>. It will then default back to its original setting.</p>
<b>Language and User</b>	<p><b>English</b> – Clicking this will allow the user to change the language of the page.</p> <p><b>(Username)</b> – Clicking this will open a list with User Center (used for editing the profile), Modify password (used to change the account password), and Logout (to logout of this account)</p>

**Input & Output Power and Energy Overview can also be viewed via the Monitoring Software. See following page for examples.**



Name	Description
<b>Input Power</b>	<p>This chart shows the power curve for each day, including solar power, battery charge/discharge power and grid import power and consumption. Hovering over an item name will highlight it in the chart. Clicking it will remove it from the list.</p>
<b>Energy Overview</b>	<p>This chart shows energy production and consumption for each day, including solar production, battery, and consumption. Hovering over an item name will highlight it in the chart. Clicking it will remove it from the list.</p> <p>Selecting 'Month' will show the energy statistics for each day.            Selecting 'Year' will show energy for each month.            Selecting 'Total' will show energy for each year.</p>

## 8.3.2 DASHBOARD (DATA TAB)

The Data Tab displays additional detailed data including technical details for PV, battery, grid, and loads, that is helpful for analysis and maintenance.

Five categories make up the Data Tab view: "Chart", "Energy", "Data History", "Local data", and "Event History." For more details on each category, please see the following tables.

### Chart

Displays various parameters in chart format over a 24-hour period. There are separate charts for "PV Side", "Battery", "AC Side" and "Backup Output".

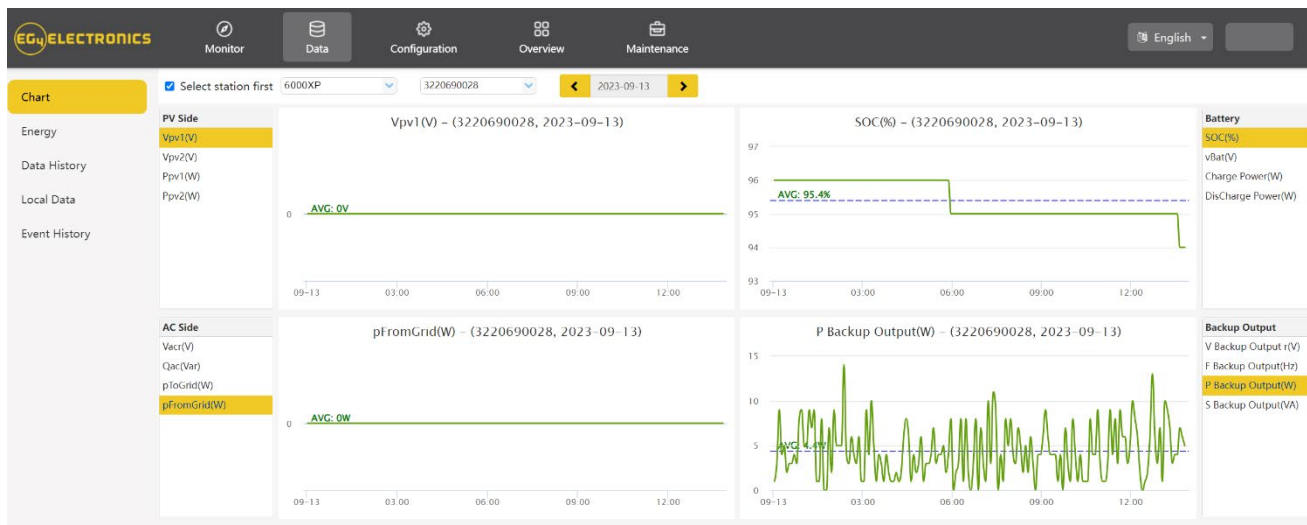

<b>Vpv 1-2 (V)</b>	Voltage of solar input
<b>Ppv 1-2 (V)</b>	Power of solar input
<b>SOC (%)</b>	Battery state of charge
<b>vBat (V)</b>	Battery voltage
<b>Charge Power (W)</b>	Battery charging power
<b>Discharge Power (W)</b>	Battery discharging power
<b>Vacr (V)</b>	Voltage of AC output
<b>pFromGrid (W)</b>	Power feed from grid to inverter
<b>V Backup Output r (V)</b>	Load rated voltage
<b>F Backup Output (Hz)</b>	Load frequency
<b>P Backup Output (W)</b>	Load output power
<b>S Backup Output (VA)</b>	Load apparent power

## Energy

Displays how key energy parameters have varied over time.

- Selecting 'Month' will show the energy statistics for each day.
- Selecting 'Year' will show energy for each month.
- Selecting 'Total' will show energy for each year.

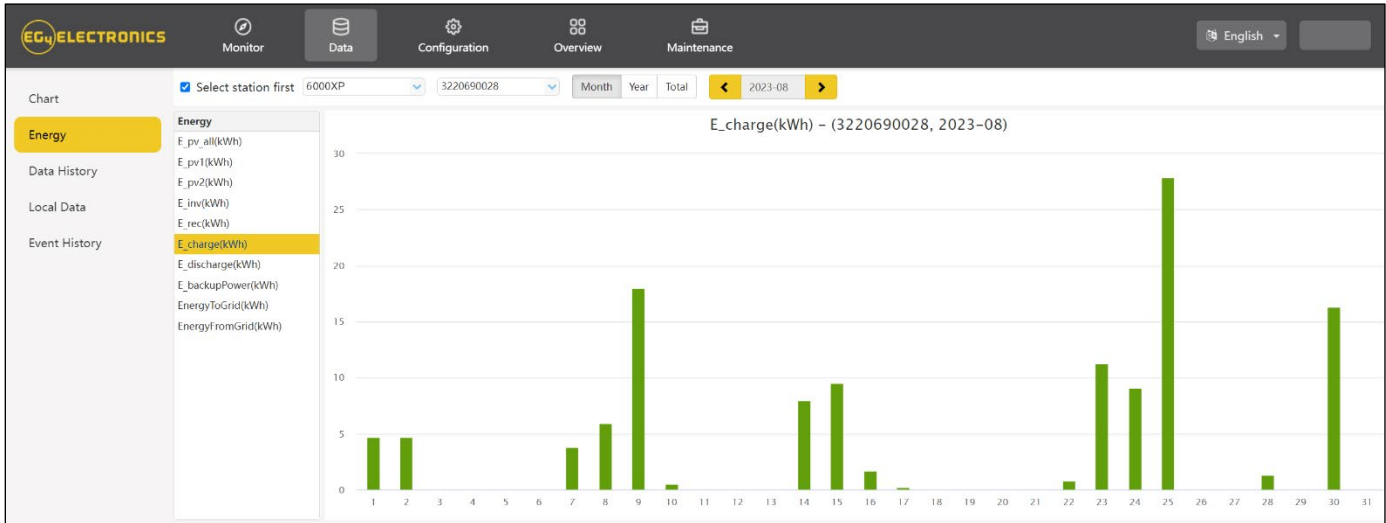

Name	Description
<b>E_pv1(kWh)</b>	Energy generated by PV string 1
<b>E_pv2(kWh)</b>	Energy generated by PV string 2
<b>E_inv(kWh)</b>	Energy output via AC output
<b>E_rec(kWh)</b>	Energy of AC charge
<b>E_charge(kWh)</b>	Energy used for battery charge
<b>E_discharge(kWh)</b>	Energy output by battery discharging
<b>E_backupPower(kWh)</b>	Load energy output
<b>EnergyToUser(kWh)</b>	Energy import from grid

## Data History

Displays the measured technical characteristics of PV, battery, load, and grid for users or their distributor's examination to promptly address any potential issues.

Advanced technical knowledge is necessary to properly comprehend this table. End users are advised to concentrate solely on the "Monitor" view, "Chart" and "Energy" sections as these only offer simple to comprehend performance data.



**HELPFUL TIP:** Data can be exported to an Excel file to provide to the distributor for technical support. Distributors can then analyze the following factors to perform quick troubleshooting for their end users.



Serial number	Time	Status	Vpv1(V)	Vpv2(V)	vBat(V)	SOC(%)	Ppv1(W)	Ppv2(W)	pCharge(%)	pDisCharge(%)	Vacr(V)	Fac(Hz)	Pinv(W)	Prec(%)	PF(%)	Vepsr(V)	Fepsr(Hz)	Pepsr(W)	pIoGrid	pIoUser	pLoad(V)	ePv1Dr	ePv2Dr	eInVDay	eInVDay
1	3220690028	2023-09-13 13:49:03	0x40	0	0	53.1	94%	0	0	7	0	0	0	0	[0]	240	60.02	5	86	0	0	0	0	0	0
2	3220690028	2023-09-13 13:43:59	0x40	0	0	53.1	94%	0	0	6	0	0	0	0	[0]	240	59.99	6	80	0	0	0	0	0	0
3	3220690028	2023-09-13 13:38:58	0x40	0	0	53.1	94%	0	0	10	0	0	0	0	[0]	240.2	60.01	7	78	0	0	0	0	0	0
4	3220690028	2023-09-13 13:33:59	0x40	0	0	53.1	95%	0	0	5	0	0	0	0	[0]	239.9	59.98	4	78	0	0	0	0	0	0
5	3220690028	2023-09-13 13:28:58	0x40	0	0	53.1	95%	0	0	6	0	0	0	0	[0]	240	60.02	4	102	0	0	0	0	0	0
6	3220690028	2023-09-13 13:23:59	0x40	0	0	53.1	95%	0	0	4	0	0	0	0	[0]	240	60	3	84	0	0	0	0	0	0
7	3220690028	2023-09-13 13:18:57	0x40	0	0	53.1	95%	0	0	10	0	0	0	0	[0]	240.2	60	7	102	0	0	0	0	0	0
8	3220690028	2023-09-13 13:13:57	0x40	0	0	53.1	95%	0	0	13	0	0	0	0	[0]	240	60	9	72	0	0	0	0	0	0
9	3220690028	2023-09-13 13:08:56	0x40	0	0	53.1	95%	0	0	14	0	0	0	0	[0]	240.1	59.99	10	75	0	0	0	0	0	0
10	3220690028	2023-09-13 13:03:55	0x40	0	0	53.1	95%	0	0	2	0	0	0	0	[0]	240	60.01	1	94	0	0	0	0	0	0
11	3220690028	2023-09-13 12:58:52	0x40	0	0	53.1	95%	0	0	9	0	0	0	0	[0]	240	59.96	7	103	0	0	0	0	0	0
12	3220690028	2023-09-13 12:53:54	0x40	0	0	53.1	95%	0	0	4	0	0	0	0	[0]	240.1	60.02	3	84	0	0	0	0	0	0
13	3220690028	2023-09-13 12:48:51	0x40	0	0	53.1	95%	0	0	9	0	0	0	0	[0]	240.2	59.98	6	103	0	0	0	0	0	0
14	3220690028	2023-09-13 12:43:53	0x40	0	0	53.1	95%	0	0	14	0	0	0	0	[0]	240	59.98	13	103	0	0	0	0	0	0
15	3220690028	2023-09-13 12:38:50	0x40	0	0	53.1	95%	0	0	9	0	0	0	0	[0]	239.9	60.02	6	78	0	0	0	0	0	0
16	3220690028	2023-09-13 12:33:50	0x40	0	0	53.1	95%	0	0	2	0	0	0	0	[0]	240	59.98	2	86	0	0	0	0	0	0
17	3220690028	2023-09-13 12:28:49	0x40	0	0	53.1	95%	0	0	2	0	0	0	0	[0]	240	60	1	95	0	0	0	0	0	0
18	3220690028	2023-09-13 12:23:48	0x40	0	0	53.1	95%	0	0	1	0	0	0	0	[0]	240.1	60.02	0	91	0	0	0	0	0	0
19	3220690028	2023-09-13 12:18:47	0x40	0	0	53.1	95%	0	0	3	0	0	0	0	[0]	240	59.98	2	94	0	0	0	0	0	0
20	3220690028	2023-09-13 12:13:45	0x40	0	0	53.1	95%	0	0	8	0	0	0	0	[0]	240.1	59.99	6	106	0	0	0	0	0	0
21	3220690028	2023-09-13 12:08:46	0x40	0	0	53.1	95%	0	0	9	0	0	0	0	[0]	240	59.98	8	98	0	0	0	0	0	0
22	3220690028	2023-09-13 12:03:45	0x40	0	0	53.1	95%	0	0	11	0	0	0	0	[0]	240.1	60.02	10	105	0	0	0	0	0	0
23	3220690028	2023-09-13 11:58:45	0x40	0	0	53.1	95%	0	0	5	0	0	0	0	[0]	240.2	60.01	5	81	0	0	0	0	0	0
24	3220690028	2023-09-13 11:53:42	0x40	0	0	53.1	95%	0	0	4	0	0	0	0	[0]	239.9	59.98	3	88	0	0	0	0	0	0
25	3220690028	2023-09-13 11:48:42	0x40	0	0	53.1	95%	0	0	6	0	0	0	0	[0]	240.1	60.02	6	110	0	0	0	0	0	0

Name	Description
Vpv/Ppv	To check the MPPT
Vo/Po/So	To check the load type and if there is an overload when in load mode
Vb/SOC	To check the current state of charge and if the battery is overcharged or overly discharged.
Vac/Fac	To evaluate Grid performance and to check if working voltage and frequency range is adjusted to comply with grid
E-xxday	To evaluate energy distribution
E-xxall	To check if the system is working well under off grid mode

### Local Data

The data captured during the offline periods are displayed in the "Local data" section (loss of Internet or Wi-Fi). The only distinction from "Data History" is that it is used for offline data recording. Local data is recorded while the system is offline for more than 20 minutes and is taken every 5 minutes. Data can be stored in the system for a maximum of 90 days.

Serial number	Time	Status	Vpv1(V)	Vpv2(V)	vBat(V)	SOC(%)	Ppv1(W)	Ppv2(W)	pCharge(%)	pDisCharge(%)	Vacr(V)	Fac(Hz)	Pinv(W)	Prec(W)	PF	Vepsr(V)	Fepsr(Hz)	Pepsr(W)
---------------	------	--------	---------	---------	---------	--------	---------	---------	------------	---------------	---------	---------	---------	---------	----	----------	-----------	----------

## Event History

The "Event History" section displays a timeline of events. (Notice and Fault events) If there is not a record of a "historical event," the inverter is properly connected and working without any issues.

Chart	<input checked="" type="checkbox"/> Select station first	6000XP	All Event	Export data		
Energy	Station	Serial number	Event Type	Event	Start Time	Time Recovered
Data History	1	6000XP	Notice	Battery voltage low	2023-09-11 12:51:43	2023-09-12 08:24:16
Local Data	2	6000XP	Notice	EPS Over load	2023-09-07 10:56:17	2023-09-07 11:06:20
Event History	3	6000XP	Notice	EPS Over load	2023-09-07 10:56:16	2023-09-07 11:06:14
	4	6000XP	Notice	Battery voltage low	2023-09-07 09:26:27	2023-09-07 09:46:26
	5	6000XP	Notice	Battery voltage low	2023-09-07 09:24:14	2023-09-07 09:44:19
	6	6000XP	Notice	EPS Over load	2023-09-07 08:06:43	2023-09-07 09:01:34
	7	6000XP	Notice	EPS Over load	2023-09-07 08:04:01	2023-09-07 08:59:12
	8	6000XP	Notice	EPS Over load	2023-09-06 16:28:16	2023-09-06 16:43:15
	9	6000XP	Notice	EPS Over load	2023-09-06 15:33:28	2023-09-06 16:23:18
	10	6000XP	Notice	EPS Over load	2023-09-06 15:33:27	2023-09-06 16:43:39
	11	6000XP	Notice	Battery voltage low	2023-09-06 09:13:52	2023-09-06 10:48:34
	12	6000XP	Notice	Battery voltage low	2023-09-06 09:09:32	2023-09-06 10:44:45
	13	6000XP	Notice	Communication failure with battery	2023-09-05 10:08:53	2023-09-05 10:11:41
	14	6000XP	Notice	Communication failure with battery	2023-09-05 09:58:16	2023-09-05 10:03:51
	15	6000XP	Fault	Internal CT offset out of range	2023-09-05 09:51:42	2023-09-05 12:12:13
	16	6000XP	Notice	Communication failure with battery	2023-09-05 09:32:20	2023-09-05 09:52:26
	17	6000XP	Notice	Communication failure with battery	2023-09-05 09:23:40	2023-09-05 09:27:20
	18	6000XP	Fault	Internal communication fault 1	2023-09-05 09:15:59	2023-09-05 09:51:42
	19	6000XP	Fault	Internal CT offset out of range	2023-09-05 09:13:28	2023-09-05 12:12:12
	20	6000XP	Notice	Battery voltage low	2023-09-01 11:54:55	2023-09-01 13:59:36
	21	6000XP	Notice	Battery voltage low	2023-09-01 11:54:40	2023-09-01 14:00:00
	22	6000XP	Notice	Battery voltage low	2023-09-01 10:14:27	2023-09-01 10:19:26

### 8.3.3 DASHBOARD (CONFIGURATION TAB)

The "Configuration" page is used for users to manage their station, dataloggers and user information.

#### Stations

The Stations section will show all stations linked to the account. Clicking on a station name will display all inverters under that station or location.

Clicking the Add Station button creates another site if the user has more than one station under the same account. This is useful for distributors who have multiple customers that would like assistance with monitoring/troubleshooting their inverters.

EG4 ELECTRONICS							English
Monitor	Data	Configuration	Overview	Maintenance			
Stations	+ Add Station		Search by station name				✕
Dongles	Station name	Country	Timezone	Daylight saving time	Create date	Action	
Devices	1 6000XP	United States of America	GMT -5	No	2023-07-24	Station Management	
Users							

## Dongles

Users can add the datalogger Serial Number (SN) in the station if they have more than one inverter in the station. The inverter will be shown on the system immediately when powered on after adding the datalogger and configuring the proper password for the Wi-Fi datalogger. Dongles can also be searched by individual serial number.

Serial number	Dongle type	Station name	Firmware	Create date	Connect Status	Action
1 BA3	Wi-Fi	6K		2023-07-24	Lost	Management
2 BA3	Wi-Fi	6K		2023-07-24	Lost	Management
3 BA3	Wi-Fi	6K		2023-07-24	Lost	Management
4 BA3	Wi-Fi	6K		2023-07-24	Lost	Management
5 BA3	Wi-Fi	6K		2023-07-24	Lost	Management



**REMINDER:** Before configuring the password for the Wi-Fi datalogger, please add the datalogger to the monitor system.

## Devices

Users can see the entire inverter list connected to the account and check if the inverter is online. Data can be exported to an Excel file for record keeping or to view specific inverter stats.

Serial number	Dongle	Station name	Phase	Device type	Power Rating	Model	Firmware	Status	Connect Status	BattParallelNum	BattCapacity	Action
1 3220690028	BA	6K	1	Eco-Hybrid	6KW	66241	cCaa-135A5B	64	Lost	0	600	Management
2 3220690036	BA	6K	1	Eco-Hybrid	6KW	66241	cCaa-135A5B	64	Lost	6	600	Management

## Users

This tab shows a full list of users, distributors and any other roles linked to the account.

End users can edit password and personal information in the user page. Distributors can add an installer account and end user account on this page.

### 8.3.4 DASHBOARD (OVERVIEW TAB)

"Overview" allows EG4 or its distributors to quickly monitor system-wide data for their end users, such as solar yields, battery discharging, and other factors.

### Station Overview

All the stations linked to the account can be found here. Clicking a station name will switch the main page to show the real time data.

Name	Status	SolarPower	ChargePower	DischargePower	Load	Solar Yield	BatteryDischarging	FeedEnergy	ConsumptionEnergy
1 6K	Offline	0 W	0 W	0 W	0 W	62.3 kWh	275.2 kWh	0 kWh	85.2 kWh

## Device Overview

All the inverters linked to the account can be found here. Clicking a serial number will switch the main page to show the real time data for that inverter.

Serial number	Status	SolarPower	ChargePower	DischargePower	Load	Solar Yield	BatteryDischarging	FeedEnergy	ConsumptionEnergy	Station name	Parallel	Action
1	Offline	0 W	0 W	0 W	0 W	46.3 kWh	153.3 kWh	0 kWh	57.4 kWh	6K		
2	Offline	0 W	0 W	0 W	0 W	16 kWh	121.9 kWh	0 kWh	27.8 kWh	6K		

## 8.3.5 DASHBOARD (MAINTENANCE TAB)

The "Maintenance" view is used for firmware updates and to remotely change settings on the inverter by selecting a station and then an inverter serial number.

Distributors can manage all settings for all inverters at once with the help of the batch setting capability supported by EG4's monitor system.



**IMPORTANT: Advanced technical knowledge is necessary to properly make changes. End users will only be able to see the "Remote Set" tab to make changes to their inverter.**

## 9. FIRMWARE UPDATES

### 9.1 FIRMWARE UPDATE VIA EG4 ELECTRONICS APP

When updating the firmware through the EG4 App, be sure to have plenty of battery life on the mobile device and do not close the application. Make sure the Wi-Fi dongle is connected securely and correctly configured for the inverter before performing the following steps.

**Step 1:** Open the EG4 Electronics App on the mobile device and select the "DOWNLOAD FIRMWARE" button.

**Step 2:** Choose the correct firmware file (contact the distributor for most up to date files) and select "DOWNLOAD" on the right side to download the file to the mobile device.

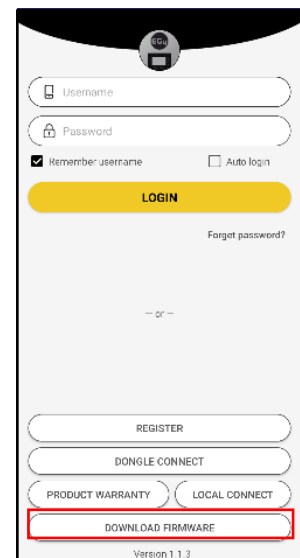

**Step 3:** Keep the app running and go to the phone’s Wi-Fi settings. Connect the mobile device to the Dongle’s network. The Dongle’s Network ID will be the same as the Dongle’s Serial Number.

**Step 4:** Return to the home screen of the app and select “LOCAL CONNECT”. Select the “Set” button on the bottom right side and proceed to the next step.

**Step 5:** After completing step 4, the Local Set Interface as shown above will appear. Swipe upward on the phone screen until the “Update Firmware” button is visible at the bottom of the app’s display.

**Step 6:** Choose the correct installation package in the dropdown box and click “UPDATE FIRMWARE” to begin the updating process.

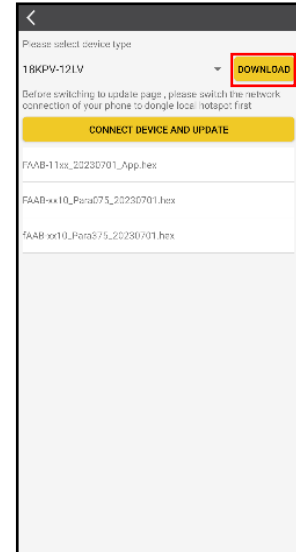

After clicking the,” UPDATE FIRMWARE” button, the update will begin. Update progress can be viewed via the app as well as the inverter’s LCD screen. Once the update is completed, a notification will appear confirming that the firmware has been successfully updated (as shown in photo). After successfully updating firmware, the inverter will restart itself.

Make sure to update all inverters installed in the same ESS to the latest firmware.

## 9.2 FIRMWARE UPDATE VIA MONITOR CENTER (WEBSITE)

**Step 1:** Distributors and installers can update the firmware for their inverters by using the EG4 Electronics website monitoring system. Please contact EG4 to ensure the latest version is applied.

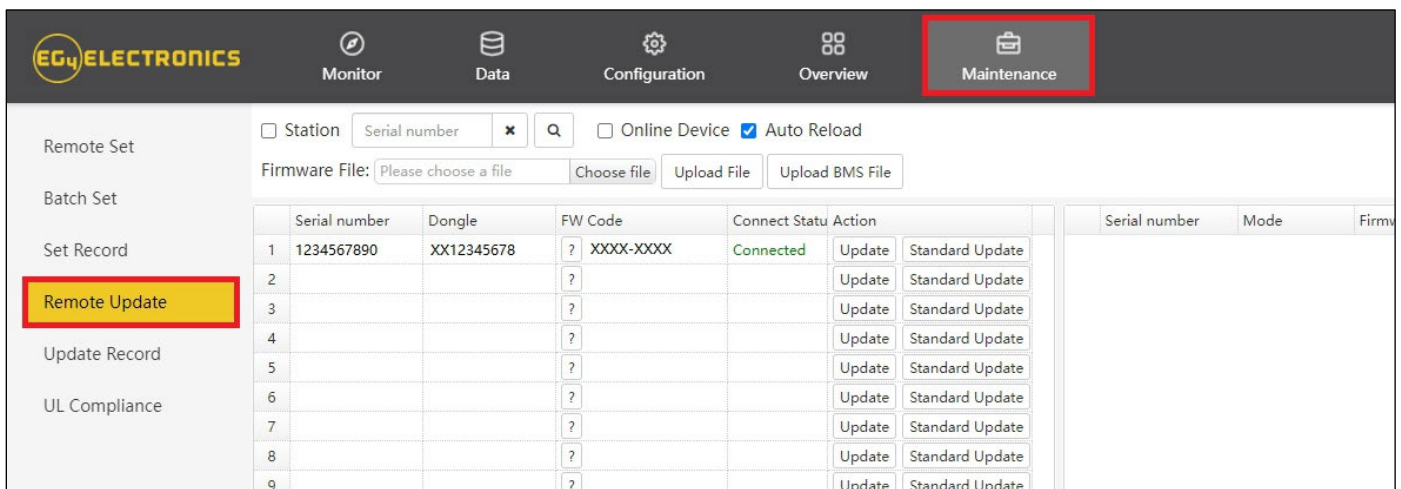

**Step 2:** Log into the EG4 Electronics Monitor System. Select “Maintenance,” and then select “Remote Update.”

**Step 3:** Choose the inverter the user is attempting to update and then select “Standard Update”. The Monitor Center will begin updating both firmware files in the inverter. The latest version of the firmware will be displayed in the bottom right window.

The screenshot shows the EG4 Electronics Monitor Center interface. The top navigation bar includes Monitor, Data, Configuration, Overview, and Maintenance. The left sidebar contains Remote Set, Batch Set, Set Record, Remote Update (highlighted in yellow), Update Record, and UL Compliance. The main content area features a search bar with a 'Station' checkbox and a search field containing 'Serial number'. Below the search bar are buttons for 'Choose file', 'Upload File', and 'Upload BMS File'. A table displays a list of inverters with columns for Serial number, Dongle, FW Code, Connect Status, and Action. The first row is highlighted, and the 'Standard Update' button in the Action column is highlighted in red.

	Serial number	Dongle	FW Code	Connect Status	Action
1	1234567890	XX12345678	? XXXX-XXXX	Connected	Update Standard Update
2			?		Update Standard Update
3			?		Update Standard Update
4			?		Update Standard Update
5			?		Update Standard Update
6			?		Update Standard Update
7			?		Update Standard Update
8			?		Update Standard Update
9			?		Update Standard Update

## 10. SMARTPHONE APP SETUP

A monitoring account must be registered and the Wi-Fi password for the Wi-Fi dongle must be set **before** using EG4's monitoring system.

### 1. Register an account

Visit <https://monitor.eg4electronics.com/> or download the 'EG4 Monitor' App to register for an end-user account. Please contact support@eg4electronics.com for distributor or installer accounts.

### 2. When registering the account, provide the following information:

- Customer code: This is the code for a distributor or installer. Please contact the distributor or installer to obtain this code.
- Dongle SN: The serial number is attached to the Wi-Fi/LAN shell.
- Dongle PIN: PIN is attached to the Wi-Fi/LAN shell below the SN.

### 3. Set the Wi-fi password

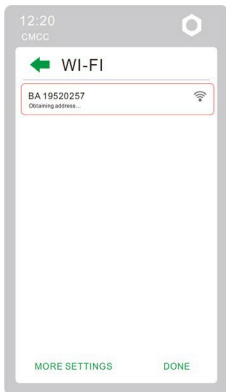

- Plug in the Wi-Fi dongle, and power on the inverter.
- Wait until any LED on the Wi-Fi module is flashing, and then connect the phone to the Wi-Fi hotspot. The hotspot name is the same as the Wi-Fi dongle serial number. (See image on left)
- Open the app. Click on "Dongle Connect". Click the Yellow refresh button to display a list of available networks. Select the home wireless network name and enter the password.
- After clicking Home Wi-Fi Connect, the Wi-Fi dongle will reset. After setting the correct password, three lights will be solid ON, which means the inverter is connected to the server. Return to the login page and input the account and password to begin monitoring the system.

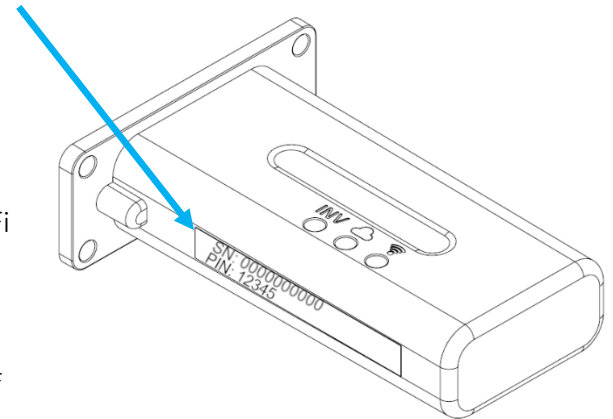
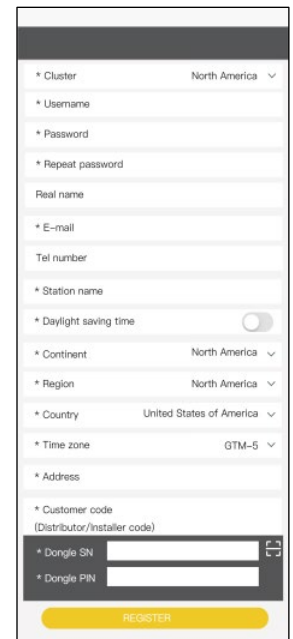
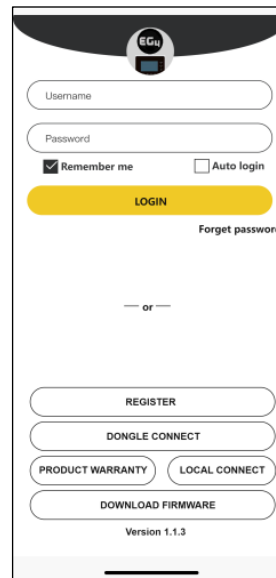

**IMPORTANT:** When following the steps above, if unable to link the dongle with the system using the Wi-Fi options, use the "Set with Bluetooth" (see image to the right) option located beneath the "Home WiFi Connect" selection to configure the dongle using Bluetooth. Remain near the device when configuring to ensure no data loss.

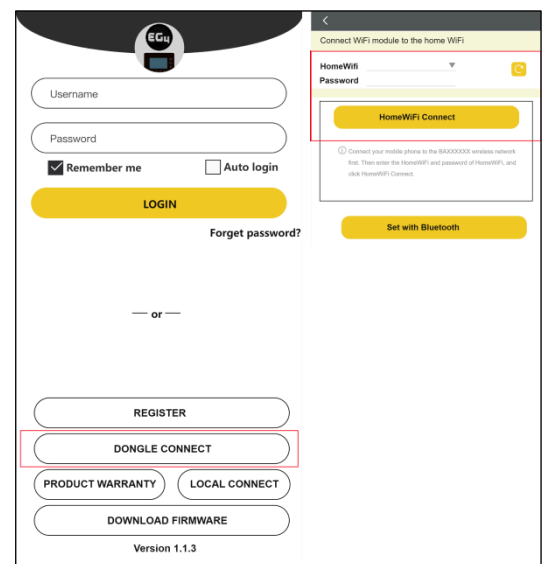



## Local Monitoring Setup with the EG4 Monitor App

If there is no Wi-Fi available at the location, the user can use the Bluetooth function on Bluetooth compatible mobile devices to monitor or set up the system.

1. Download the EG4 Monitor App.
2. Select “Local Connect.” The user can now monitor and set up the system via Bluetooth or TCP Connect.
3. Click “Local Connect.” Select “Bluetooth Connect.” On the next page, select the serial number of the unit that has the dongle connected.

Now the user may view the system information through Bluetooth connection on the mobile device.

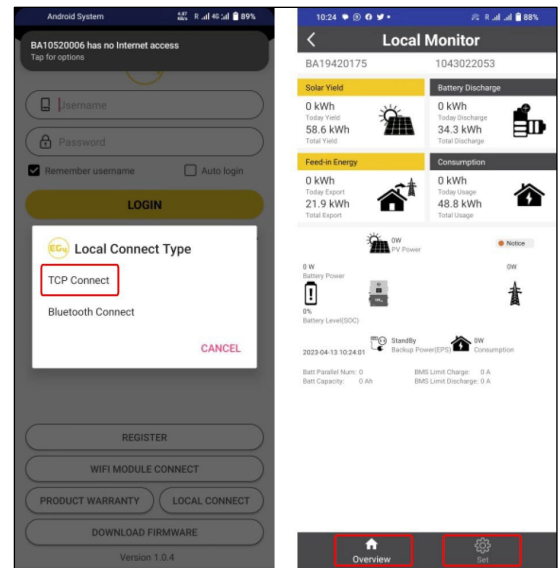



## 11. WORKING MODES

The table below describes how the inverter's LCD will display the different modes of operation per any given scenario.

Mode	Diagram	Comments
Bypass Mode		AC powers the load
PV Charge Bypass		PV charges the battery while AC powers the load
BAT Off-Grid		Battery powers the load
PV+BAT Off-Grid		PV & Battery power the load

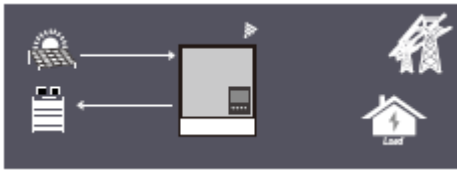
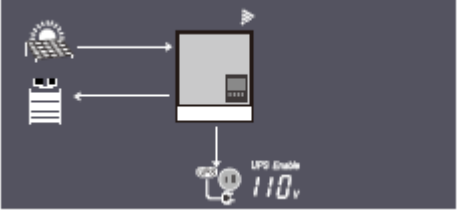

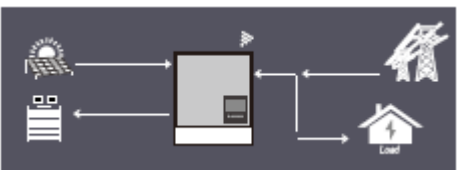
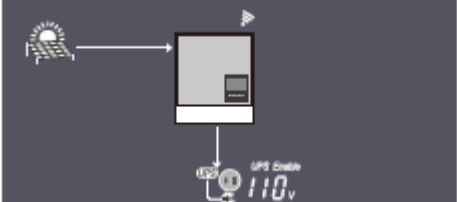
<p><b>PV Charge</b></p>		<ol style="list-style-type: none"> <li>1. With EPS output switch off, the inverter charges the battery only</li> <li>2. With battery power off, PV can wake up the battery automatically</li> </ol>
<p><b>PV Charge+Off-Grid</b></p>		<p>PV charges the battery and powers the load</p>
<p><b>AC Charge</b></p>		<ol style="list-style-type: none"> <li>1. AC powers the battery from AC Input (Grid) or Generator Input (GEN)</li> <li>2. When batteries reach low threshold, charge bank with Grid/GEN</li> </ol>
<p><b>PV+AC Charge</b></p>		<p>PV &amp; AC charge the battery. AC is from AC Input (Grid) or Generator Input (GEN)</p>
<p><b>PV Off-Grid</b></p>		<p>PV powers the load. NOTE: Load power depends on PV energy input and may be unstable</p>

## 11.1 RAPID SHUTDOWN (RSD)

The inverter supports a rapid shutdown system that complies with 2017 and 2020 NEC 690.12 requirements. A rapid shutdown switch should be connected to the RSD terminals on the master inverter and mounted in a readily accessible location outdoors (check with the local AHJ for specific requirements). For paralleled systems, the RSD needs only to connect to the master inverter. When the switch is engaged, it will shut down all inverters in parallel past the master.



**NOTE: When using supported EG4 batteries in closed-loop communications with the inverter, the RSD also initiates ESS Disconnect as required by NEC code**

The system can utilize an External E-Stop Switch if the AHJ deems it necessary. When doing so, setting 28 must be set to Enable to engage the function.

### Type of External E-Stop Switch for RSD Requirements:

The external switch must have normally closed contact type for emergency shutdown.

## 11.1.1 EXTERNAL RSD WIRING INSTRUCTIONS

The image below showcases an example diagram using a Tigo RSD Transmitter (not included). Wire the E-Stop Switch into the RSD terminals on the master inverter, as shown below, following the specific switch's specifications. Please refer to the switch's manual for exact specifications and wiring instructions.

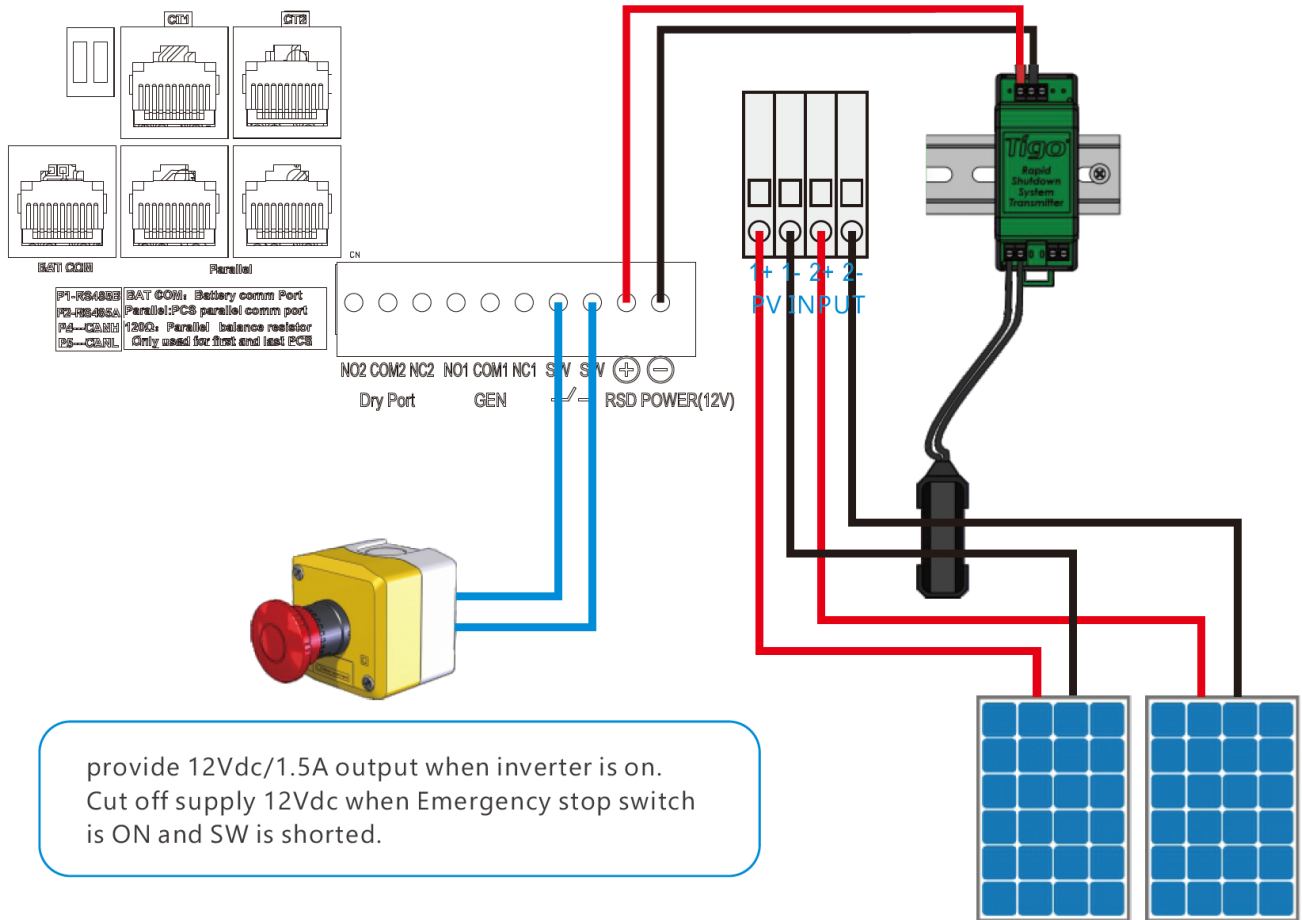

## 11.2 LCD DISPLAY AND SETTINGS

The user can wake up the LCD screen by simply pressing the Enter button. System status, real-time power, and daily and accumulated energy information can all be conveniently viewed on the inverter's LCD screen. Additionally, users can check the alarm and fault record on the display for troubleshooting.

LED Indicator		Info	
1 (Normal)	Green	Solid ON	Working normal
		Flashing	Fast: Warning Slow: Firmware Update
2 (Fault)	Red	Flashing	Fault detected in the inverter

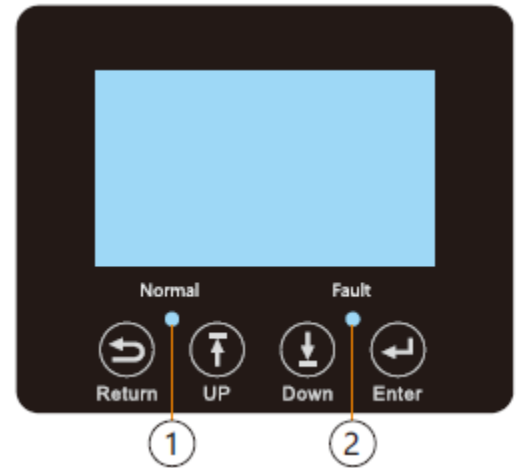

### 11.2.1 LCD DISPLAY

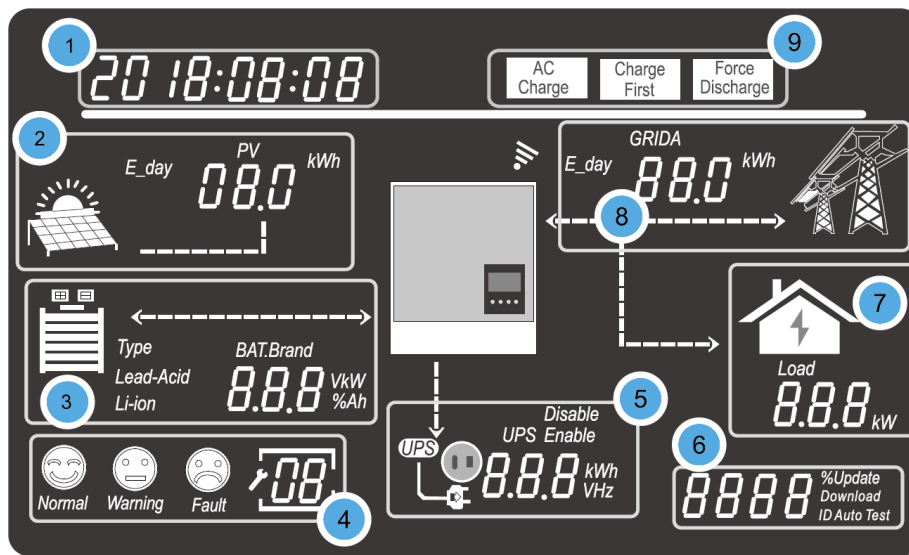

The data on the LCD screen updates every 3 seconds as various information is displayed in each section. See table on next page for more details.

No.	Description	Comments
1	General Information Display Area	Displays the current system status by default. Pressing the Up/Down buttons will cycle through Time, Date, Single/Parallel Inverter Setting, Inverter Serial Number, and Firmware Version. When entering new settings, the selection information is displayed in this area.
2	Photovoltaic (PV) Data	Cycles every 3 seconds through: PV1 Voltage, PV2 Voltage, PV1 power, PV2 Power, PV1 Energy (day), PV2 Energy (day), PV1 Energy (total to-date), and PV2 Energy (total to-date).
3	Battery Information and Data	Displays the battery type and brand. For lead-acid batteries, this area will cycle every 3 seconds through the CV voltage, Float Charge Voltage, Cut-off Voltage, and Discharge End Voltage. For Lithium-ion batteries, this area will cycle every 3 seconds through the Voltage (V), SOC (%), Power (kW), and Capacity (Ah).

4	System Status and Codes	<p>There are three system status icons: Normal, Warning and Fault, and a 2-digit field that displays codes.</p> <ul style="list-style-type: none"> <li>Status = 'Normal': nothing is displayed in the 2-digit field</li> <li>Status = 'Warning': warning code is displayed in the 2-digit field.</li> <li>Status = 'Fault': fault code is displayed in the 2-digit field.</li> <li>System in 'Setting' mode: current Setting is displayed in the 2-digit field.</li> </ul>
5	UPS/EPS output information and data	When the UPS function is enabled, this area will cycle through UPS1 V, UPS1 Hz, UPS1 kW, UPS2 V, and UPS2 kW. There is no UPS2 Hz, because it will always be the same as UPS1 frequency by default. UPS1=Phase1=L1, UPS2=Phase2=L2.
6	Programming & the percentage of AC output power	When in Off-Grid mode, this area will display the percentage of the maximum AC output power. Relevant information is displayed during firmware updates
7	Load consumption	Displays the power consumption by the load in the On-grid Mode.
8	Grid and Generator information	Cycles through: Grid1 Voltage, Grid2 Voltage, Grid Hz, Gen1 Voltage, Gen2 Voltage, Gen Hz, Grid Power, Grid Energy (day), and Grid Energy (total to-date). Grid1=Phase1=L1, Grid2=Phase2=L2; Gen1=Phase1=L1, Gen2=Phase2=L2
9	Working mode area	When the user makes changes to the 6000XP inverter through the LCD, this area will display the AC Charge, Charge First and Force Discharge settings. Otherwise, this area displays nothing.

## Inverter Status Displays

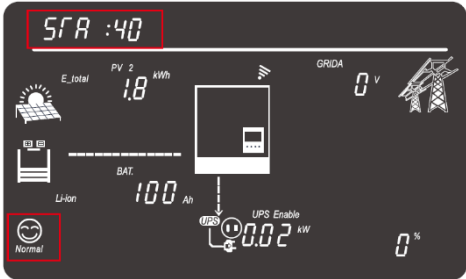
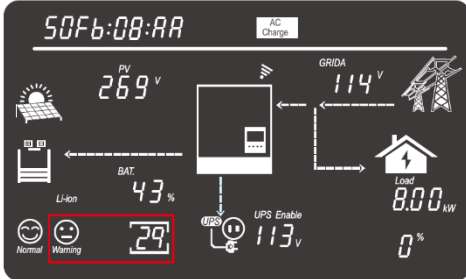
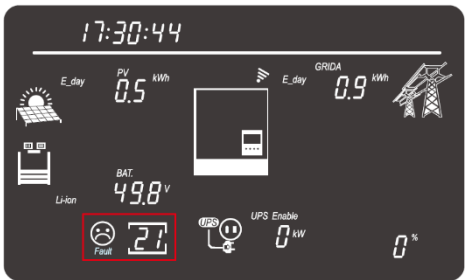
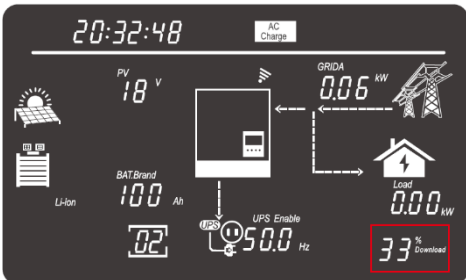
<p><b>Normal/Running Status:</b></p> 	<p><b>Warning Status:</b></p> 
<p><b>Fault Status:</b></p> 	<p><b>Flash Status:</b></p> 

## Grid Status for GRIDA (Utility):

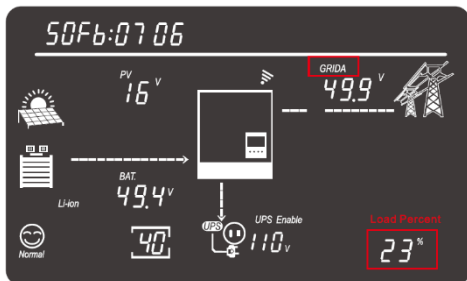

**NOTE:** When GRIDA is displayed, AC utility information is displayed. Percent at bottom right is load% (e.g., 23%).

## Grid Status for GRIDB (Generator):

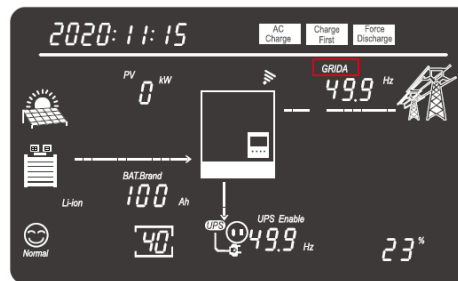

**NOTE:** When GRIDB is displayed, Generator information is displayed. Percent at bottom right is load% (e.g., 23%).

## 12. LCD SETTINGS

There are four (4) buttons on the LCD screen used to select various modes and make changes to settings:



**Step 1:** Press the Enter button for ≈3 seconds to enter the **setting mode**. The data in the 'General Information Display Area' will flash and the 2-digit Setting field will be displayed.

**Step 2:** Press Up/Down to cycle through the settings (1-29).



**Step 3:** Press Enter to confirm the desired setting.

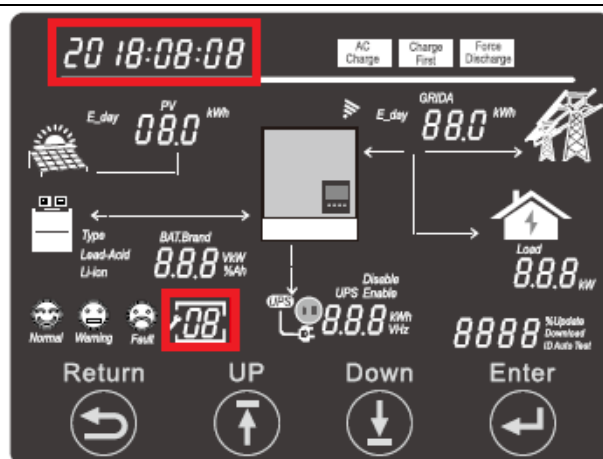

**Step 4:** Press Up/Down to cycle through the settings.

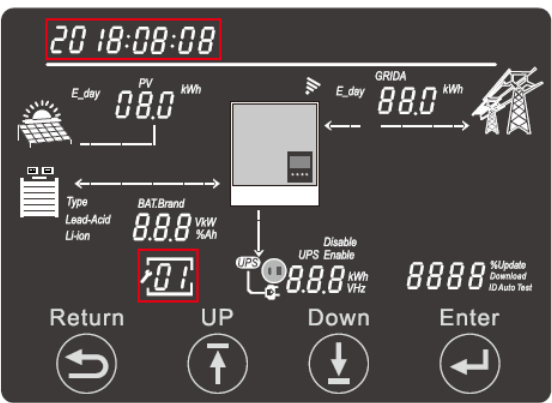
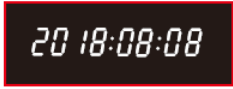
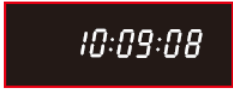
**Step 5:** Press Enter to confirm the desired setting.

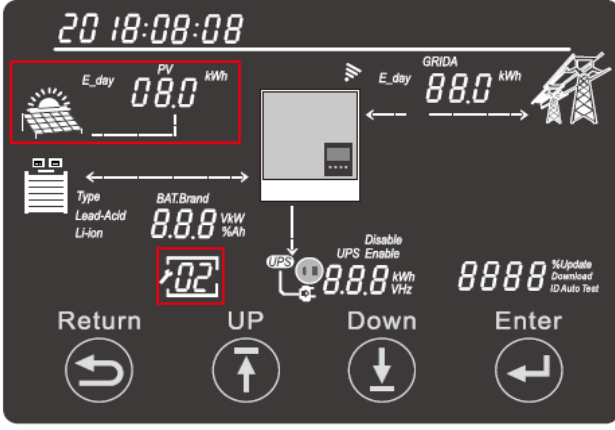

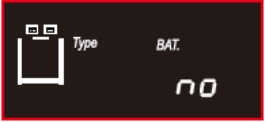
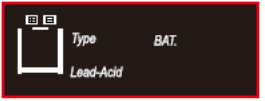
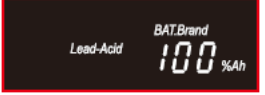
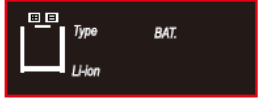
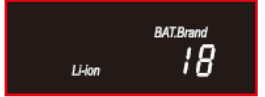
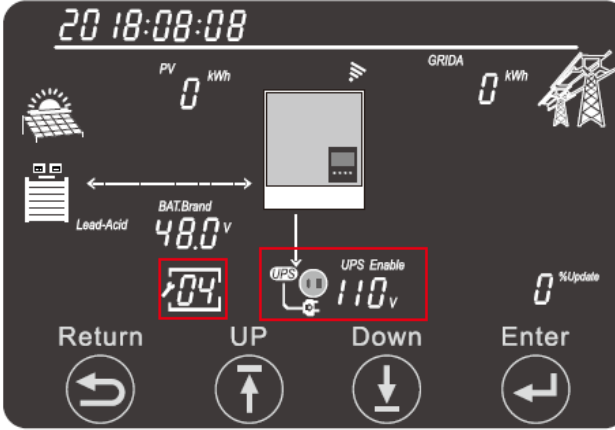
#	DESCRIPTION	SETTING OPTION(S)
1	Date & Time	 <p>Setting Year/Month/day</p>  <p>Setting hour/minute/second</p>  <p>This setting allows the user to set the Local Date and Time.</p>

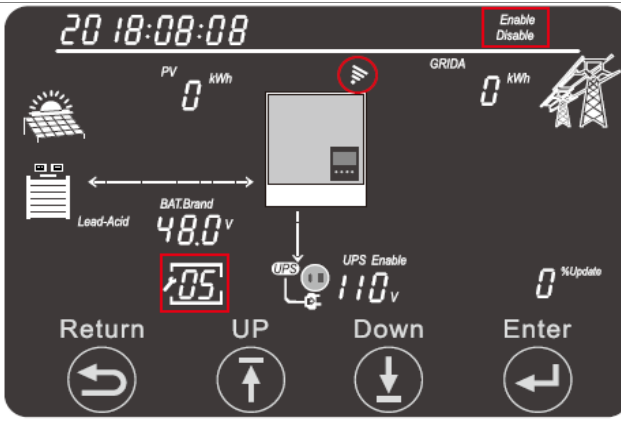
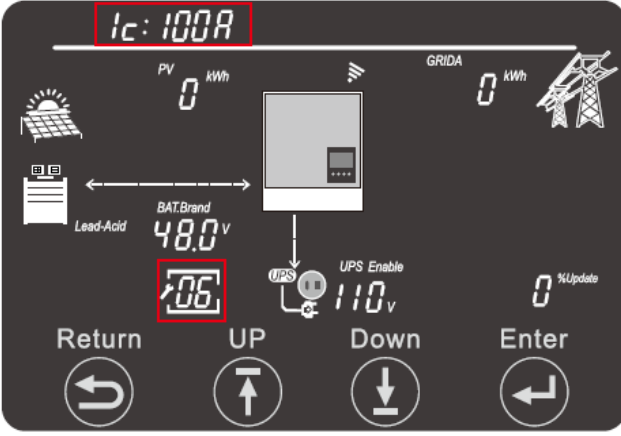

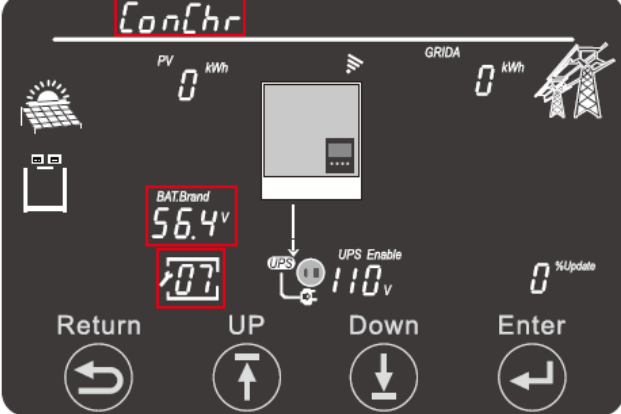

<p>2</p>	<p>PV Input Mode</p>		<p>This setting allows the user to set the PV Input Mode.</p> <p><b>PV Input Type:</b>  <b>S</b>=two independent strings,  <b>P</b>=same string input for 2 MPPTs          Default: S</p>
<p>3</p>	<p>Battery</p>	<p>This setting allows the user to identify if Batteries will be used in the system and, if yes, the type of batteries (Lead-Acid or Lithium).</p> <p>Operate with <b>No Battery</b></p> <p><b>Step 1:</b> Choose battery type first. When “no” begins flashing, select Enter to operate with No Battery</p> <p> <b>REMINDER: It is NOT recommended to operate without batteries</b></p> <hr/> <p>Operate with Lead-Acid Battery</p> <p><b>Step 1:</b> Choose battery type first. When “Lead-Acid” begins flashing, select Enter to operate with Lead-Acid Batteries.</p> <p><b>Step 2:</b> Enter the Battery Capacity (Ah)</p> <hr/> <p>Operate with Lithium Battery</p> <p><b>Step 1:</b> Choose battery type first. When “Li-ion” begins flashing, select Enter to operate with Lithium Batteries.</p> <p><b>Step 2:</b> Enter the Battery Brand (e.g., 0=EG4, 2=Pylon, 6=LuxPower, 8=Dyness)</p>	    
<p>4</p>	<p>UPS Output Voltage and Frequency</p>		<p>This setting allows the user to set the inverter output voltage and frequency.</p> <p><b>AC Output Voltage:</b>          200VAC, 208VAC, 220VAC, 230VAC, 240VAC          Default: 240VAC</p> <p><b>AC Output Frequency:</b>          50Hz, 60Hz          Default: 60Hz</p>

<p>5</p>	<p>Buzzer Enable</p>		<p>This setting allows the user to enable or disable the inverter buzzer.</p> <p><b>Inverter Buzzer:</b> Enable/Disable Default: Enable</p>
<p>6</p>	<p>Ic: Maximum Charge Current (Utility+Solar)</p>		<p>This setting allows the user to set the maximum charge current.</p> <p><b>Total Charge Current:</b> Range: 0 – 125A Default: 125A</p> <p><b>AC Charge Current:</b>  Range: 0 – 125A Default: 30A</p> <p><b>Generator Charge Current:</b>  Range: 0 – 110A Default: 30A</p>
<p>7</p>	<p>ConChr: CV Voltage (Lead-Acid Only)</p>		<p>This setting allows the user to set the Charging Voltage for Lead-Acid batteries only.</p> <p><b>Lead-Acid Charging Voltage:</b> Range: 50.0 – 59.0VDC Default: 56.4VDC</p>



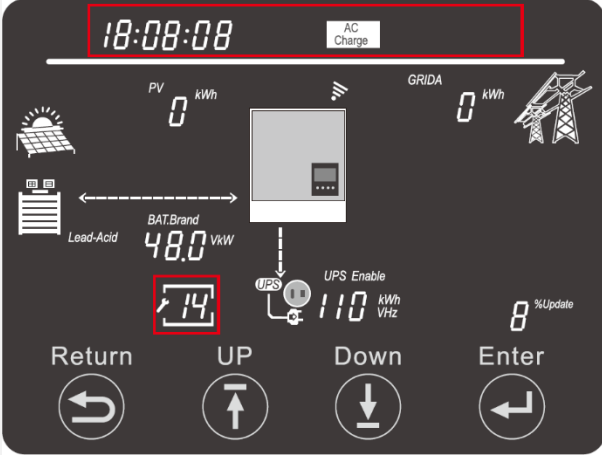

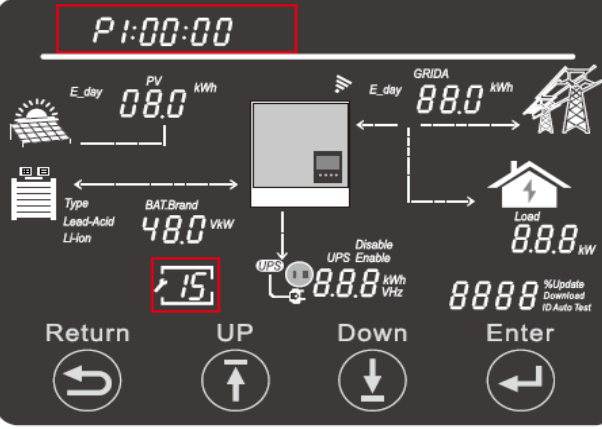
<p>8</p>	<p>FloChr: Floating Charge Voltage (Lead-Acid Only)</p>		<p>This setting allows the user to set the Lead-Acid Battery Float Charge Voltage.</p> <p><b>Lead-Acid Floating Charge Voltage:</b>  <b>Range:</b> 50.0 – 56.0VDC          Default: 54.0VDC</p>
<p>9</p>	<p>Id: Maximum Discharge Current</p>		<p>This setting allows the user to set the Maximum Discharge Current.</p> <p><b>Maximum Discharge Current:</b>  <b>Range:</b> 10 – 140A          Default: 140A</p>
<p>10</p>	<p>TEOd: Discharge Control Type (Volt/SOC)</p>		<p>This setting allows the user to select Voltage or SOC as the trigger for battery discharge.</p> <p><b>TEOd:UoL</b></p> <p><b>TEOd:SoC</b></p>
<p>11</p>	<p>CutOFF: Cut off Voltage/SOC</p>		<p>This setting allows the user to set the cutoff Voltage or SOC based on the selection made in Setting 10, TEOd.</p> <p><b>Cutoff Voltage:</b>          40.0 – On-Grid EOD Voltage          Default: 42V</p> <p><b>Cutoff SOC:</b>  <b>Range:</b> 0 – On-Grid EOD SOC%          Default: 15%</p>



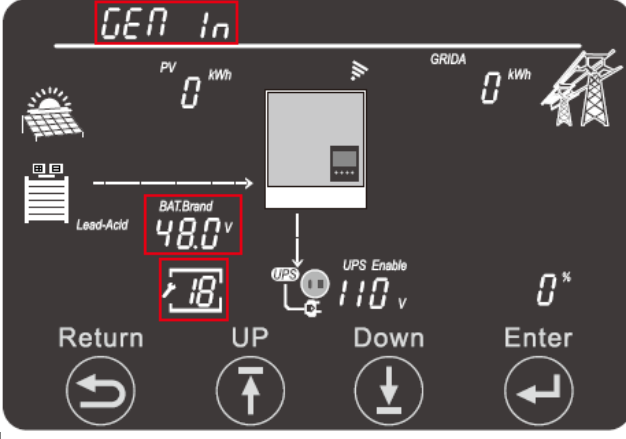
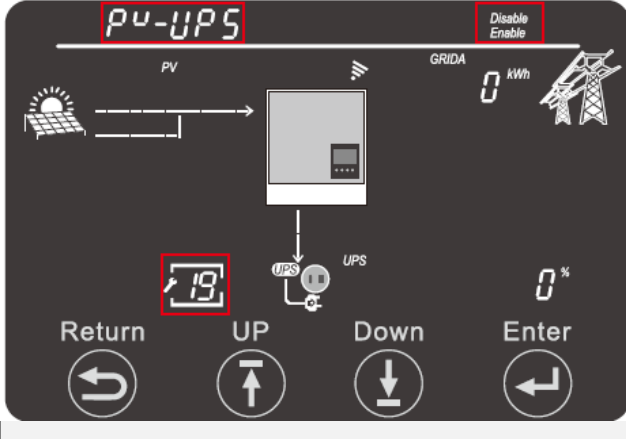
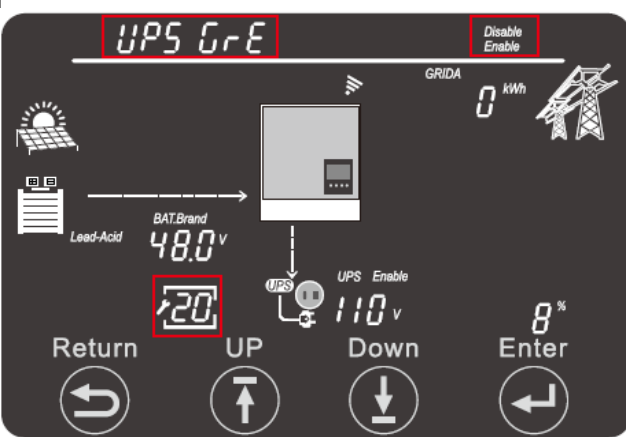

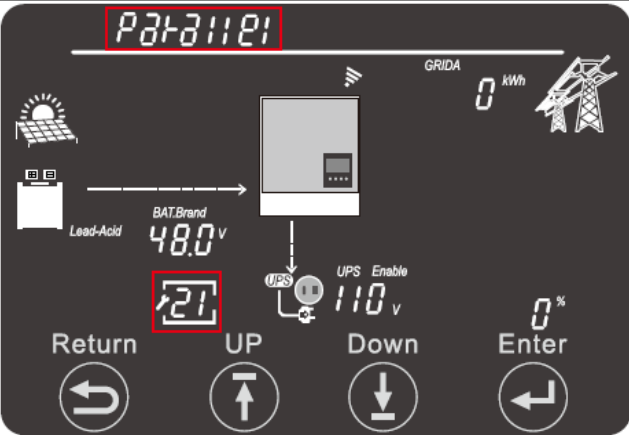

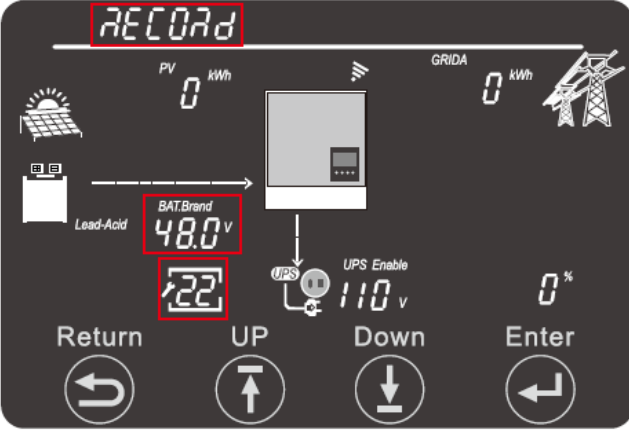

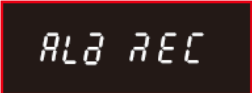

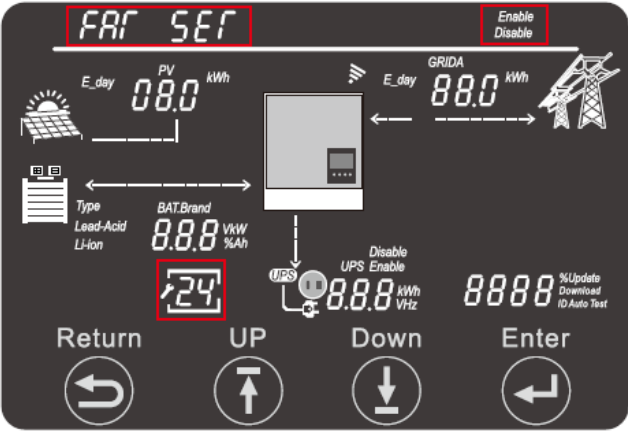
<p>12</p>	<p>Eod: Battery Discharge Cutoff</p>	<p>The top screenshot shows the 'Eod' menu with 'BAT.Brand' set to 42.0V. The bottom screenshot shows the 'Eod' menu with 'BAT.Brand' set to 15%.</p>	<p>This setting allows the user to set the End-Of-Discharge Voltage and SOC parameters.</p> <p><b>End of Discharge Cutoff Voltage:</b> Range: Cutoff Voltage – 58V Default: 42V</p> <p><b>End of Discharge Cutoff SOC:</b> Range: Cutoff SOC – 90% Default: 15%</p>
<p>13</p>	<p>AC In: AC Voltage Range Setting</p>	<p>The screenshot shows the 'AC In' menu with 'AC In' set to 13. The display also shows 'BAT.Brand' at 48.0V and 'UPS Enable' at 110V.</p>	<p>This setting allows the user to set the AC Input Voltage Range</p> <p><b>AC In Voltage Range:</b> APL – 90-280VAC UPS – 170-280VAC</p> <div style="border: 2px solid red; padding: 5px; width: fit-content; margin: 5px auto;">AC In: APL</div> <div style="border: 2px solid red; padding: 5px; width: fit-content; margin: 5px auto;">AC In: UPS</div>

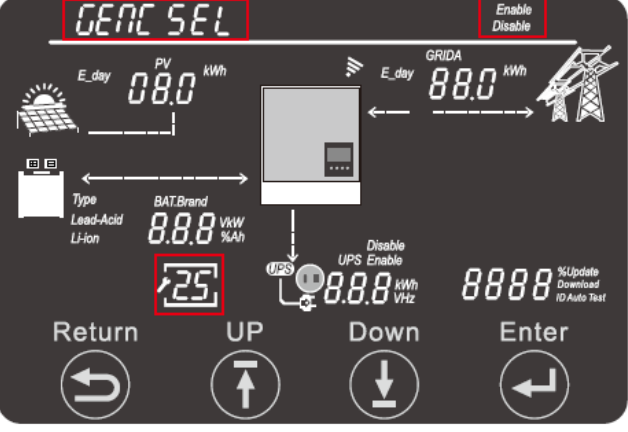
<p>14</p>	<p>AC Charge Setting</p>	 <p>To configure AC charging, the user must first enable AC Charging, confirm the full battery SOC value, and set the confirmation time periods 1, 2, and 3.</p>	
<p>15</p>	<p>AC Input Load Timer Settings</p>	 <p>This setting allows the user to set the Start/End times for the Grid/Utility to supply power to the load.</p>	 <p><b>Start Time1-3:</b> 00:00 – 23:59 Default: 00:00 – 00:00 <b>End Time1-3:</b> 00:00 – 23:59 Default: 00:00 – 00:00</p>

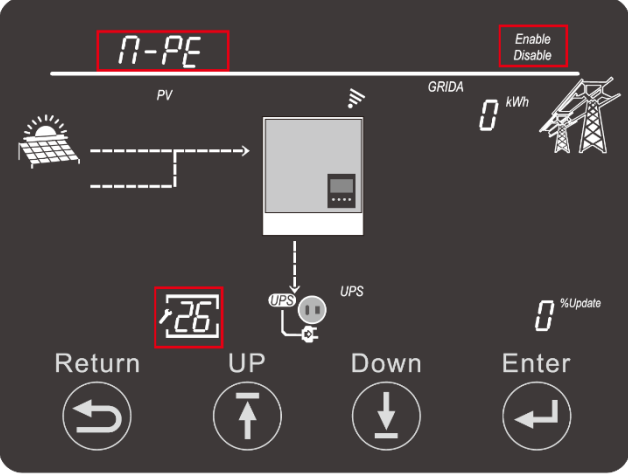

<p>17</p> <p>Battery Wakeup</p>			<p>This setting allows the user to enable or disable the battery wakeup feature. It is not applicable if no battery type is defined.</p> <p><b>Range:</b> Enable/Disable</p>
<p>18</p> <p>Max Generator Input Power</p>			<p>This setting allows the user to set the maximum generator input power.</p> <p><b>Range:</b> 0-7369W  <b>Default:</b> 7369</p>
<p>19</p> <p>PV Off-Grid Enable/Disable</p>			<p>This setting allows the user to configure the system to only use PV for loads. Due to voltage fluctuation, power output may be inconsistent.</p> <p><b>Range:</b> Enable/Disable  <b>Default:</b> Disable</p>
<p>20</p> <p>Power Save Function</p>			<p>This setting allows the user to enable or disable the Power Save Functions, 'Green Function' and 'ECO Mode'.</p> <p><b>Range:</b> Enable/Disable</p> <p>The default settings for both functions are set to disabled.</p>

<p>21</p>	<p>Parallel Setting</p>	   <p><b>Parallel Type:</b> NoPL (Not Parallel), 1PH (Single Phase), 3PH (Three Phase)  Default: NoPL  <b>Parallel Phase:</b> P1 (U-Phase), P2 (V-Phase), P3 (W-Phase)  Default: P1 (U-Phase)  <b>Battery Share Enable/Disable:</b> Disable/Enable  Default: Disable</p>	<p>This setting allows the user to select the inverter paralleling configuration.</p>
<p>22</p>	<p>Error/Alarm Record</p>	   <p><b>Error Record:</b>-&gt;Record Setting-&gt;Record Message  (Year:Month:Day; Hour:Min:Sec; Error Code)  <b>Alarm Record:</b>-&gt;Record Setting-&gt;Record Message  (Year:Month:Day; Hour:Min:Sec; Alarm Code)</p>	<p>This setting allows the user to see Error and Alarm records.</p>

<p>24</p> <p>Fan Speed Setting</p>	 <p><b>Fan1/2 Slope: Enable/Disable</b> Default: Disable</p> <p><b>Range:</b> 20 – 100% Default: 70%</p>	<p>This setting allows the user to adjust the operation of the Inverter’s two fans. The user can set the speed (20-100%) and enable or disable the slope (Enabling the slope allows the fans to ramp up/down to/from the fan speed setting).</p>  
<p>25</p> <p>Generator Charge Setting</p>	 <p><b>Generator Charge Control Type: VOL or SOC</b> Default: VOL</p> <p><b>Generator Charge Control Value (Volts):</b> Start Voltage: 38.4 – 52V, End Voltage: 48 – 59V</p> <p><b>Generator Charge Control Value (SOC):</b> <b>Range:</b> Start SOC: 1 – 90%, End SOC: 20 – 100%</p>	<p>This setting allows the user to select the Generator charge control parameter (Voltage or SOC) and the associated Start/End Voltage or SOC.</p>    
<p>26</p> <p>Neutral-Ground Bonding Function</p>		<p>This setting allows the user to enable or disable the internal neutral-ground bond. The inverter must be in standby to make this change. Turn the “EPS Output” switch to off to engage standby mode.</p> <p><b>Range:</b> Enable/Disable Default: Enable</p>  

<p>27</p>	<p>PV Isolation Protection</p>	<p>The screen displays 'PV-ISO' in the top left and 'Enable/Disable' in the top right. It features a central diagram of a PV system connected to a grid. Below the diagram are four navigation buttons: 'Return' (left arrow), 'UP' (up arrow), 'Down' (down arrow), and 'Enter' (right arrow). A small 'UPS' icon is also visible.</p>	<p>This setting allows the user to enable or disable the PV Isolation Protection of the MPPT.</p> <p><b>Range:</b> Enable/Disable  <b>Default:</b> Disable</p> <p><b>Enable</b></p> <p><b>Disable</b></p>
<p>28</p>	<p>RSD Function</p>	<p>The screen displays 'RSD' in the top left and 'Enable/Disable' in the top right. It features a central diagram of a PV system connected to a grid. Below the diagram are four navigation buttons: 'Return' (left arrow), 'UP' (up arrow), 'Down' (down arrow), and 'Enter' (right arrow). A small 'UPS' icon is also visible.</p>	<p>This setting allows the user to enable or disable the RSD function of the inverter.</p> <p><b>Range:</b> Enable/Disable  <b>Default:</b> Enable</p> <p><b>Enable</b></p> <p><b>Disable</b></p>
<p>29</p>	<p>AFCI Protection</p>	<p>The screen displays 'AFCI' in the top left and 'Enable/Disable' in the top right. It features a central diagram of a PV system connected to a grid. Below the diagram are four navigation buttons: 'Return' (left arrow), 'UP' (up arrow), 'Down' (down arrow), and 'Enter' (right arrow). A small 'UPS' icon is also visible.</p>	<p>This setting allows the user to enable or disable the Arc-Fault Circuit Interrupter protection of the inverter.</p> <p><b>Range:</b> Enable/Disable  <b>Default:</b> Enable</p> <p><b>Enable</b></p> <p><b>Disable</b></p>

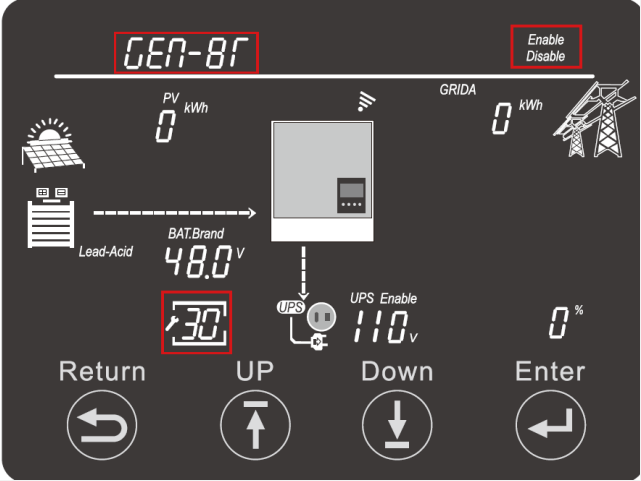
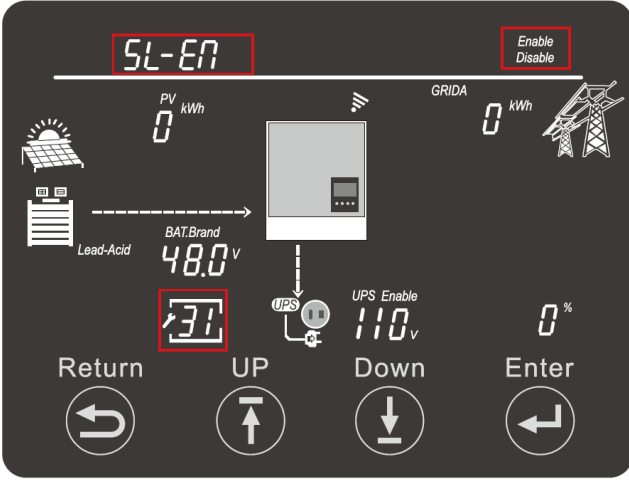

<p>30</p>	<p>GEN BOOST</p>		<p>This setting allows the user to enable or disable the GEN Boost function of the inverter.  <b>Range:</b> Enable/Disable</p> <p><b>Enable</b></p> <p><b>Disable</b></p>
<p>31</p>	<p>Smart Load Enable/Disable</p>	 	<p>This setting allows the user to enable or disable the Smart Load function of the inverter.  <b>Range:</b> Enable/Disable  <b>Default:</b> Disable</p> <p><b>Enable</b></p> <p><b>Disable</b></p> <p><b>Grid On Range:</b>          Enable/Disable  <b>Default:</b> Disable</p>

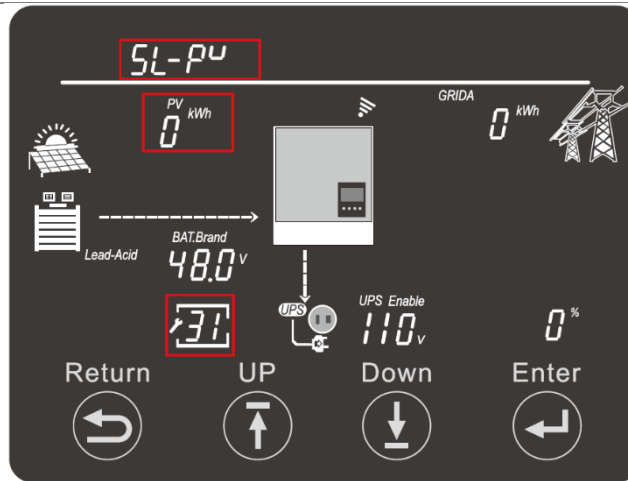

**PV Power Range:** 0 – 25.5kW  
Default: .05kW

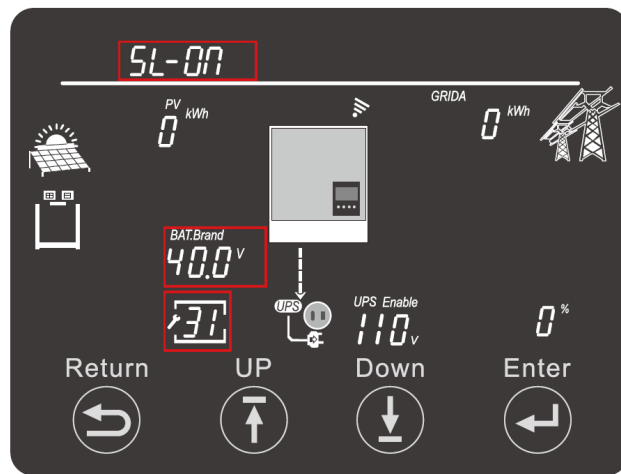

**Smart Load On Range:**  
VOLT: 40 – 59V  
Default: 54V  
SOC 0 – 100%  
Default: 90%

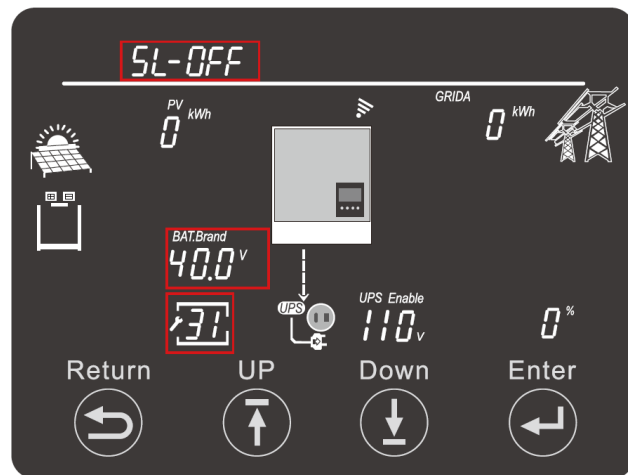

**Smart Load Off Range:**  
Volt: 40 – 59V  
Default: 48V  
SOC: 0 – 100%  
Default: 60%



31 AC Couple

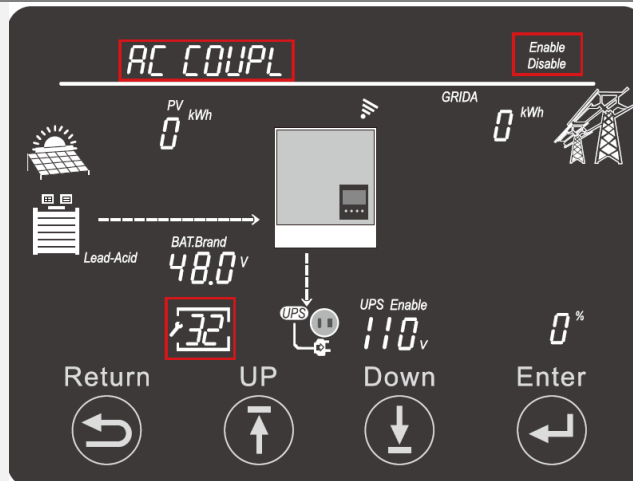

This setting allows the user to enable or disable the AC Couple function of the inverter.

**Range:** Enable/Disable  
**Default:** Disable

**Enable**

**Disable**

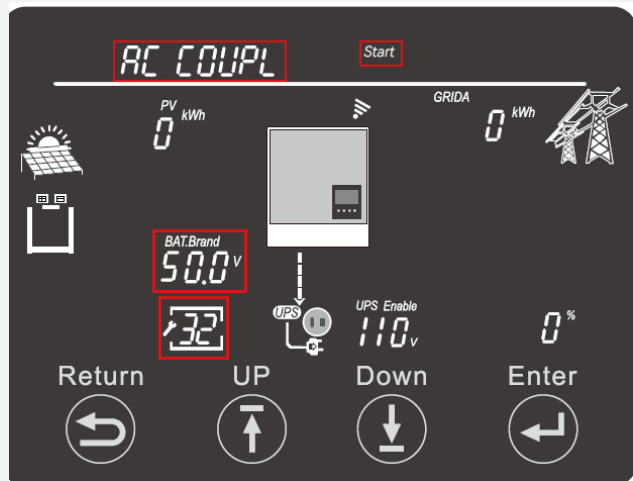

**AC Couple Start Range:**

Volt: 40 – 59B

Default: 50V

SOC: 0 – 101%

Default: 50%

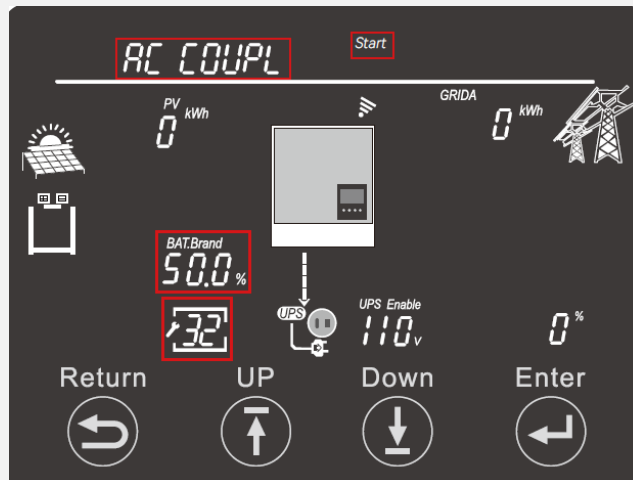

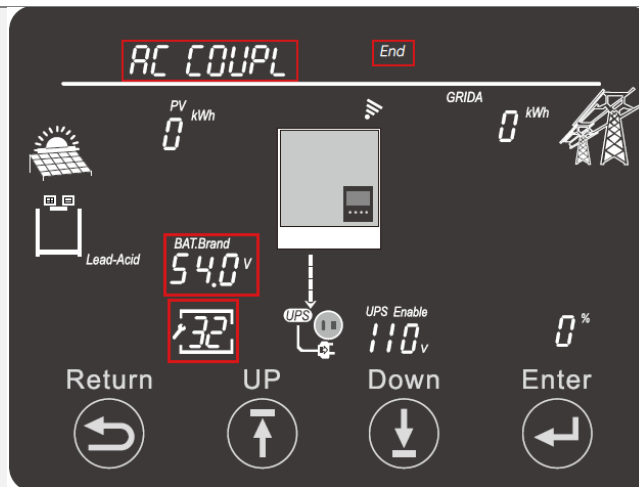

**AC Couple End Range:**  
Volt: 40 – 59V  
Default: 54V  
SOC: 0 – 101%  
Default: 90%

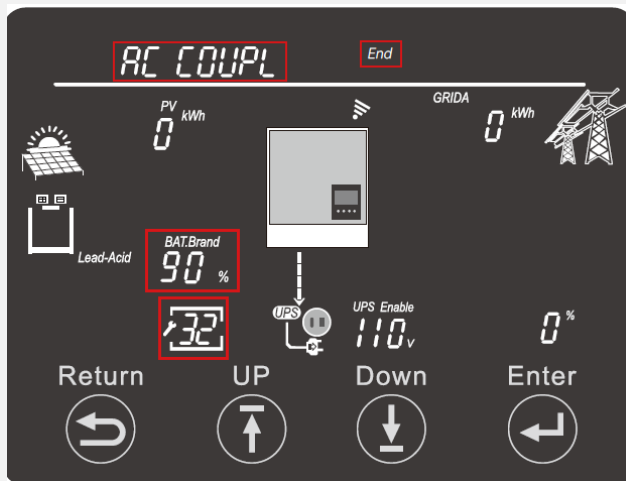

## 13. INVERTER START-UP AND SHUT-DOWN PROCEDURE

### 13.1 START-UP

Follow the steps outlined below to ensure proper start-up and shut-down procedures to avoid potential component damage.

1. Ensure all circuit breakers are in the open (OFF) position.
2. Using a multimeter, check the battery bank to ensure no voltage (DC) is present.
3. Check the external PV Isolator Switch via multimeter to ensure the voltage (DC) is in the MPPT's optimal operating range.
4. If utilizing AC input, double check each hot line to neutral coming into inverter to ensure voltage is in operating range of the unit.
5. Upon confirming all voltages are within the inverter's operating range, close (ON) the battery breaker on the front of the unit. Close the external battery breaker between bank and inverter (if equipped).
6. Begin powering batteries on one at a time, starting with the master, in  $\approx 5$  second intervals.
7. Close the external PV isolator switch (if equipped). Close PV breaker on the side of the unit.
8. If using AC input, close external breaker between panel and inverter. Next, close the GRID breaker on the front of the unit.
9. Power on the inverter via the power switch on the side of the unit.
10. Close external AC Output breaker (if equipped) going to panel. Turn ON EPS Output (AC Output) switch on side of unit to begin powering loads.



**DANGER: Never disconnect battery, PV, or AC input power under loads. If there is an emergency and users must shut down the inverter, please follow the steps outline below.**

### 13.2 SHUT-DOWN

1. Turn OFF EPS Output on side of inverter.
2. Open (OFF) GRID/GENERATOR breaker on front of unit.
3. Open LOAD breaker on front of unit. Open external AC output breaker (if equipped).
4. Open external PV isolator switch. Open PV breaker on side of the unit.
5. Open Battery Breaker on front of unit. Open external battery breaker (if equipped).
6. Power down batteries one at a time starting with the master.
7. Turn power switch on side of unit to OFF.

## 14. STATUS, WARNING, & ERROR CODES

### 14.1 STATUS CODES

Under normal operating conditions, the inverter LCD will display a smiling face (Normal) icon in the lower left corner along with the status code in the upper left corner. View the table below for a list of status codes and explanations.

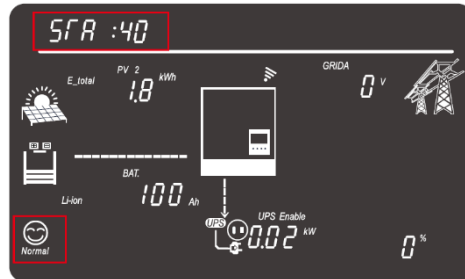

CODE	STATUS	DESCRIPTION
00	Standby	Inverter is in standby status.
02	FW Updating	Inverter is updating firmware.
08	PV Charge	Solar power exclusively charges the battery, with a maximum capacity limited by the battery's charging power. This mode commonly activates when the EPS switch is off.
10	Battery On-grid	Grid power is on with no PV input. Inverter is set in AC First or inverter is set in AC Charge while AC Charge requirement not met.
11	Bypass	Inverter is in one of three modes and supplies load in AC only: <ol style="list-style-type: none"> <li>1. Inverter is in standby mode</li> <li>2. Inverter is in ECO mode</li> <li>3. Inverter is in fault mode</li> </ol>
14	PV & Battery On-Grid	When there is PV current, the inverter will operate in option 1 or 2 below: <ol style="list-style-type: none"> <li>1. Inverter is set to use AC First, grid AC will take load first and PV will charge the battery.</li> <li>2. Inverter is set to use AC Charge; grid AC will take load first and then AC charge if PV is not sufficient.</li> </ol>
19	PV Charge + Bypass	The load is supplied by grid power. Solar power is dedicated solely to charging the battery and is limited to the maximum charging capacity of the battery.
20	AC Charge	Grid power is supplying load and charging battery simultaneously.
40	Battery Off-grid	Grid power is off, and the inverter supplies the load with only battery power.
80	PV Off-grid	Grid power is off, and the inverter supplies the load with available solar power.
C0	PV & Battery Off-grid	Grid power is off. Inverter supplies the load with a combination of solar and battery power. Solar will charge batteries while supplying loads if PV input is greater than loads.
88	PV Charge Off-grid	Grid power is off. Solar power is used to supply the load and charge batteries simultaneously.

## 14.2 WARNING CODES

When the inverter detects errors, the LCD will display a neutral face (warning) icon in the lower left corner along with the warning code. View the table below for a list of warning codes and explanations.

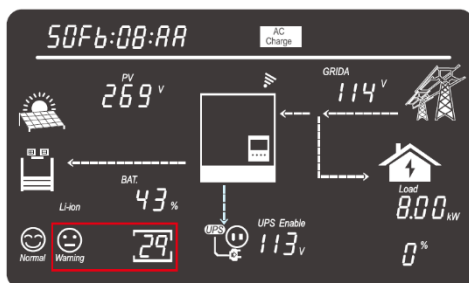

CODE	WARNING INFO	DESCRIPTION	TROUBLESHOOTING
00	Communication failure with battery	The battery is not receiving CAN or RS485 data	<ol style="list-style-type: none"> <li>1. Check the PIN layout of the Comm cable on both the inverter and battery side.</li> <li>2. Check if the Comm cable is connected in the correct comm port (CAN or RS485).</li> <li>3. Check the battery DIP switch settings.</li> <li>4. Verify a supported battery protocol is configured using the battery compatibility list.</li> </ol>
01	AFCI Com failure	Inverter does not communicate with AFCI module.	Restart Inverter. If the error persists, contact the distributor.
02	AFCI High	PV arc fault is detected	Check each PV string for correct open circuit voltage and short circuit current. If the PV string voltage and current are within inverter specifications, please clear the fault on inverter LCD. If the error persists, please contact the distributor.
03	Meter communication failure	Inverter failed to communicate with the meter.	Restart the inverter to clear the error. If the error persists, please contact the distributor.
04	Battery fault	Battery communication is normal, but the BMS is not allowing charging and discharging	<ol style="list-style-type: none"> <li>1. Check the PIN layout of the Comm cable on both the inverter and the battery end.</li> <li>2. Using the battery compatibility list, verify a supported battery protocol is being used.</li> <li>3. Check if there is fault on battery's indicator. If there is a fault, please contact the distributor.</li> <li>4. Restart batteries and ensure the communication cables are installed correctly. If the error persists, please contact the distributor.</li> </ol>
06	RSD Active	Rapid shutdown is activated.	Check if the RSD switch is pressed.

08	Firmware mismatch	Firmware version is mismatch between the microprocessors.	<ol style="list-style-type: none"> <li>1. If a firmware update was performed, verify the firmware update successfully completed.</li> <li>2. Update to the latest firmware (all inverters in parallel).</li> <li>3. Following the proper shut-down steps, turn off the inverter, turn it on again after 3 minutes. Check if the error is cleared.</li> <li>4. If the error persists, contact the distributor.</li> </ol>
09	Fan Stuck	A cooling fan is stuck.	<ol style="list-style-type: none"> <li>1. Check if there is any foreign object blocking the fan causing it to stop.</li> <li>2. Reinsert the fan cable on the interface board</li> <li>3. Press the RSD switch to check if the fan is working.</li> <li>4. Restart the inverter. If the error persists, please contact the distributor.</li> </ol>
12	Bat on Mos	The reverse mosfet does not turn on.	<ol style="list-style-type: none"> <li>1. Following the proper shut-down steps, turn off the inverter, turn it on again after 3 minutes. Check if the error is cleared.</li> <li>2. If the error persists, please contact the distributor.</li> </ol>
13	Over temperature	NTC temperature reading is higher than 87°C	<ol style="list-style-type: none"> <li>1. Check if there is a stuck fan.</li> <li>2. Verify the air ducts are not blocked.</li> <li>3. Perform regular cleaning for the dust filters.</li> <li>4. Reinsert the fan cable on the interface board.</li> </ol>
15	BatReverse	Polarity reversal when battery is connected to inverter.	Verify the positive and negative battery connections to inverter are properly installed. If the error persists, contact the distributor.
18	AC Frequency out of range	After having self-adjusted to grid frequency, the AC input frequency is out of range	Check AC frequency to ensure it is in the operable range. Turn off grid input or restart the inverter to have self-adjustment again.
19	AC inconsistent in parallel system	<ol style="list-style-type: none"> <li>1. In single-phase parallel system, the AC input voltage or frequency between the master and sub inverter is inconsistent.</li> <li>2. In three-phase parallel system, the AC input voltage or frequency among the inverters of same phase is inconsistent or the configured phase and detected phase of the sub inverter is inconsistent</li> </ol>	<ol style="list-style-type: none"> <li>1. Ensure the AC input is from a common source and installed to each inverter in parallel.</li> <li>2. Restart the inverter, if the error persists, contact the distributor.</li> </ol>
20	PV Isolation low	ISO protection was triggered.	<ol style="list-style-type: none"> <li>1. Check if there is an insulation issue of PV input cables.</li> <li>2. Check if there are any broken PV cables.</li> <li>3. Verify the panels are properly grounded.</li> <li>4. Keep the cables away from wet areas.</li> </ol>
25	Battery voltage high	Battery voltage is higher than 59V	Check the operation range of the battery and make sure it is within the range: 40 - 59Vdc, if not, power off the battery and disconnect it from the system.

26	Battery voltage low	Battery voltage is lower than cut off voltage limitation or 40V.	<ol style="list-style-type: none"> <li>1. Check the setting for the low voltage warning and SOC.</li> <li>2. Check if the battery output is low.</li> </ol>
27	Battery open	The battery voltage is lower than 40V.	<ol style="list-style-type: none"> <li>1. Verify the battery is connected.</li> <li>2. Check the breaker state of the battery side.</li> <li>3. Check if the battery has run out and protected itself.</li> </ol>
28	EPS overload	Load port voltage is low due to overload issue.	<ol style="list-style-type: none"> <li>1. Check if the EPS load is too high.</li> <li>2. Check if the PV and battery is not powerful enough to take the loads.</li> <li>3. Load percent is lower than 100%. Wait for 10 minutes or turn off the EPS switch and then turn it on again.</li> </ol>
29	EPS voltage high	When working in off-grid mode, the EPS output RMS value is higher than nominal EPS voltage +30V	<p>Verify if there is a device causing surges on the loads side. Recovery time is 20 minutes to clear the error.</p> <p>Restart the inverter. If the the error persists, contact the distributor.</p>
31	EPS DCV high	High DC voltage component on EPS output when running off-grid.	Restart the inverter. If the error persists, contact the distributor

## 14.3 FAULT CODES

When the inverter detects faults, the LCD will display a sad face (fault) icon in the lower left corner along with the fault code. View the table below for a list of fault codes and explanations.

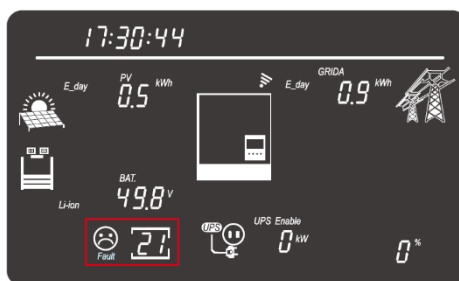

CODE	FAULT INFO	DESCRIPTION	TROUBLESHOOTING
00	Internal communication fault	The Comm CPU lost data from the Control CPU or the data from Control CPU is incorrect.	<ol style="list-style-type: none"> <li>1. Check if the firmware update has successfully completed.</li> <li>2. Update to the latest firmware.</li> <li>3. Restart the inverter to clear the error.</li> </ol>
02	Bat On Mos Fail	Battery reverse connection damaged the anti-reverse MOS or sampling error	Restart the inverter. If error persists, contact the distributor
03	CT Fail	The internal CT offset error in the inverter control program.	<ol style="list-style-type: none"> <li>1. Update to the latest firmware</li> <li>2. Restart the inverter to clear the error.</li> <li>3. If error persists, contact the distributor</li> </ol>

08	CAN communication error in parallel system	Comm data lost in parallel system	<ol style="list-style-type: none"> <li>1. Check if it is the parallel system, if no, please set "NO Parallel"</li> <li>2. Check if the parallel cable looks correct, and it should be the Cat-5 straight-wired cable.</li> <li>3. Check if the configuration of DIP switches on inverters are correct, please refer to the parallel connection guidance.</li> </ol>
09	No master in parallel system	There is no master distributed in the parallel system.	<ol style="list-style-type: none"> <li>1. Check parallel setting for Master/Slave to ensure there is only one Master set</li> <li>2. Restart the inverter to clear the error.</li> </ol>
12	UPS output short circuit	When working in off-grid mode, there is a short circuit issue in the load output	<ol style="list-style-type: none"> <li>1. Power off the inverter first.</li> <li>2. Check if there is a short circuit issue of the load side.</li> <li>3. check if L, N connection of one of the inverters has been reversed.</li> </ol>
13	UPS reserve current	In a parallel system, the reverse power is greater than the specified value.	<ol style="list-style-type: none"> <li>1. Check if the parallel inverters have been set as "No Parallel", set them as "Single-phase Parallel".</li> <li>2. Check if the parallel cable looks correct using a Cat-5 straight-wired cable.</li> <li>3. Check if the configuration of DIP switches on inverters are correct, refer to the parallel connection guidance.</li> <li>4. If using a single inverter, confirm the AC input and load (Application Setting) is set to "No Parallel"</li> <li>5. Confirm that the load port wiring is consistent, if it is a parallel system. Please strictly follow the manual for wiring.</li> </ol>
15	Phase error in three phase system	In parallel system, the system type configurations between the inverters are inconsistent or lack of phase.	<ol style="list-style-type: none"> <li>1. Check if it is a three-phase parallel system, if no, please set "Single-phase parallel" or "No Parallel" accordingly.</li> <li>2. If using a three-phase parallel system, check if the issue is a lack of phases.</li> <li>3. Check L, N connection and breaker status.</li> </ol>
16	Relay fault	There is a fault with a relay	Restart inverter. If error persists, contact the distributor
17	Internal communication fault 2	The BUS1 voltage is higher than 150V and MPPT SPS is working, but the Com board does not receive the Comm data from the MPPT board or it receives abnormal data	<ol style="list-style-type: none"> <li>1. Check if the firmware for both Comm and MPPT are up to date.</li> <li>2. Manually turn off the POWER switch, turn it on again after 3 minutes, restart the inverter to check if the error is cleared.</li> <li>3. If the error persists, contact the distributor.</li> </ol>
18	Internal communication fault 3	The Control board does not receive the comm data from the Com board or it receives abnormal data.	<ol style="list-style-type: none"> <li>1. Check if the firmware for both Comm and DSP are updated to the latest version.</li> <li>2. Please manually turn off the POWER switch, turn it on again after 3 minutes to restart the inverter to check if the error is cleared.</li> <li>3. If error persists, contact the distributor</li> </ol>



19	Bus voltage too high	BUS1 or BUS2 voltage is over range.	<ol style="list-style-type: none"> <li>1. Check if the PV input voltage is greater than 480VDC (see name plate) and try to reduce the panels</li> <li>2. Update to the latest firmware</li> </ol>
20	AC connection fault	<ol style="list-style-type: none"> <li>1. Connecting AC input cable to EPS (Loads) port by mistake.</li> <li>2. Connecting AC input cable to Gen port by mistake when AC couple or smart load mode.</li> </ol>	<ol style="list-style-type: none"> <li>1. Check if the AC input is installed to Load/ Gen port by mistake</li> <li>2. Restart the inverter to clear the error.</li> <li>3. If fault persists, contact the distributor</li> </ol>
21	PV voltage too high	The PV1 voltage or PV2 voltage higher than 480Vdc.	Turn off the PV input first and check if the PV input voltage is too high (refer to the specification of name plate) and try to reduce the panels.
22	Over current internal	Over current protection in hardware level triggered.	Manually turn off the POWER switch, turn it on again after 3 minutes to restart the inverter to check if the error is cleared
24	PV short	Over current protection was triggered, or PV input current is higher than 23A	<ol style="list-style-type: none"> <li>1. Turn off the PV input first.</li> <li>2. Check the voltage of the PV strings and the PV resistance of inverter side with multimeter.</li> <li>3. Check the wiring of the PV string to ensure there is no short circuit.</li> </ol>
25	Temperature too high	Temperature reading of the NTC is higher than 92°C or there is a NTC open issue (-25°C)	<ol style="list-style-type: none"> <li>1. Check if the air duct or vents are blocked.</li> <li>2. Reinsert the fan cable on the interface board.</li> <li>3. The internal temperature of the inverter is too high, turn off the inverter for 10 minutes, then restart the inverter.</li> <li>4. Place the unit in standby mode. If the fault still occurs, there may be a problem with temperature sampling.</li> </ol>
26	Internal Fault	BUS1 voltage is lower 50V than PV input, or BUS1 is lower 50V than BUS2.	Restart inverter. If error persists, contact the distributor
28	Sync signal lost in parallel system	Parallel sync signal for control clock or grid frequency is abnormal.	<ol style="list-style-type: none"> <li>1. Ensure paralleling cables are connected to proper ports between inverters</li> <li>2. Restart the inverter to clear the error.</li> <li>3. Ensure that all inverters in the parallel system are updated to the latest firmware.</li> <li>4. Strictly follow the manual for wiring.</li> </ol>
29	Sync trigger signal lost in parallel system	Parallel sync trigger signal for work modes switching between Inverters is abnormal.	<ol style="list-style-type: none"> <li>1. Ensure that a T568B Ethernet cable (shipped with the inverter) is used to parallel between inverters in the correct ports</li> <li>2. Check if the configuration of DIP switches on inverters are correct, please refer to the parallel connection guidance</li> <li>3. Ensure that all inverters in the parallel system are updated to the latest firmware.</li> </ol>

31	Internal communication fault 4	MPPT board fails to receive the comm data from COM board or receive the abnormal data	<ol style="list-style-type: none"><li>1. Check if the firmware for both Comm &amp; MPPT are successfully completed.</li><li>2. Update to the latest firmware.</li><li>3. Manually turn off the POWER switch, turn it on again after 3 minutes to restart the inverter to check if the error is cleared.</li><li>4. If fault persists, contact the distributor.</li></ol>
----	--------------------------------	---	--

## 15. INVERTER MAINTENANCE

Electrical equipment must be properly maintained to increase longevity and consistency. Follow the steps below to help prevent component damage/deterioration.

1. Inspect the inverter every month to confirm nothing covers the inverter heatsink. If there is cover, shut down the inverter and clear the heat sink to restore proper cooling.
2. Inspect the inverter every 3 months to verify the operating parameters are normal, and there is no abnormal heating or noise from any components in the system.
3. Inspect the inverter every 6 months to check for any damaged cables, accessories, or terminals.

If unable to identify the source of any potential abnormal operations, please contact the distributor's technical support team for additional information.

## 16. WARRANTY INFORMATION

For information regarding warranty registration on EG4® Electronics products, please navigate to <https://eg4electronics.com/warranty/> and select the corresponding product to begin the registration process.





**CONTACT US**

[support@eg4electronics.com](mailto:support@eg4electronics.com)

(903) 609-1988

[www.eg4electronics.com](http://www.eg4electronics.com)